

Fax Server ISDN Manual

V4.1

VC1558



vidicode

Vidicode

Blauw-roodlaan 140
2718 SK Zoetermeer
The Netherlands

Phone

+31(0)79 3617181

Fax

+31(0)79 3618092

Sales

+31(0)79 3471010

Support

+31(0)79 3471005

Email

vidicode@vidicode.nl

Internet

www.vidicode.nl

The Fax Server ISDN – desktop models

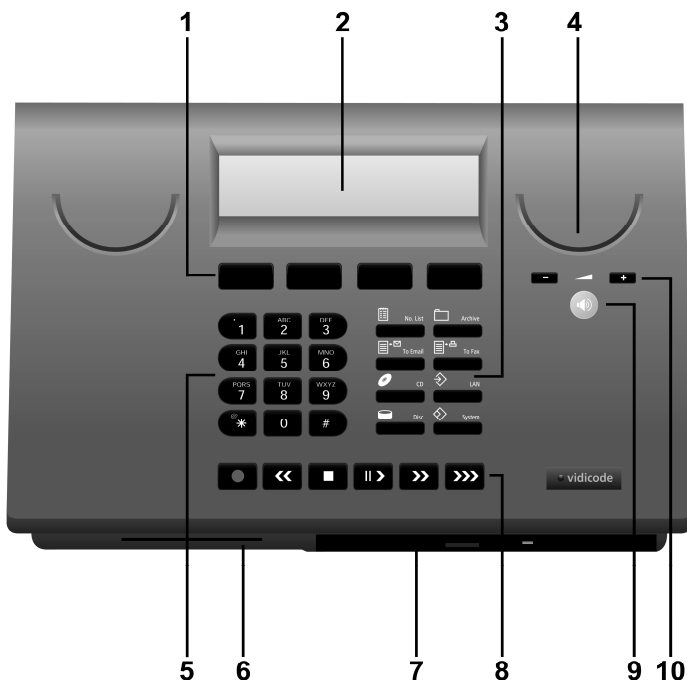

1. Menu keys
2. Backlight Display
3. Function keys
4. Speaker
5. Alfa-Numerical keys
6. CryptoCard reader
7. CD Recorder
8. Recorder keys
9. Speakerphone key
10. Volume adjustment

The Fax Server ISDN 19" models - Front panel

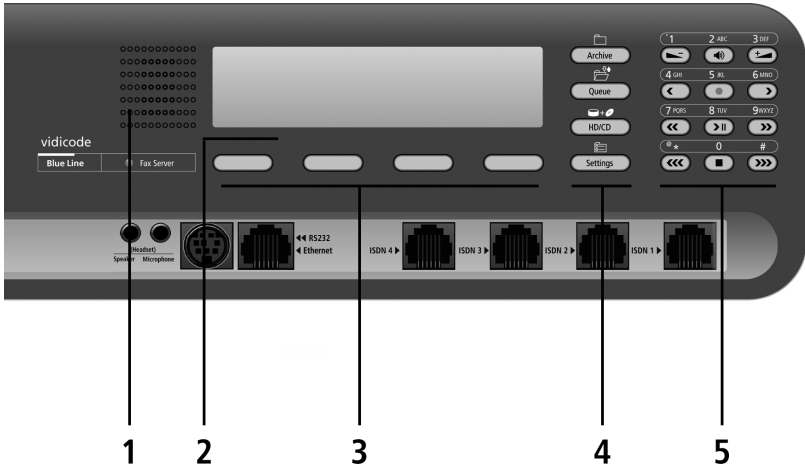

1. Internal loudspeaker
2. Backlight Display
3. Menu keys
4. Function keys
5. Alfa-Numerical / Recorder keys

Connections Fax Server PRI - on 19" model

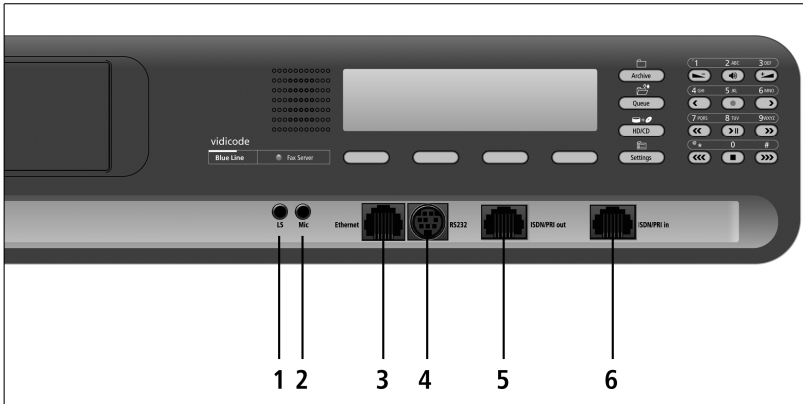

1. Loudspeaker 3.5 mm mini jack
2. Microphone 3.5 mm mini jack
3. Ethernet/LAN RJ45
4. RS 232 9 pin female serial connector
5. ISDN/PRI Out RJ45
6. ISDN/PRI In RJ45

Connections Fax Server ISDN - desktop model

1. Power
2. Loudspeaker
3. Microphone
4. RS 232 serial connection
5. Ethernet/LAN
6. ISDN BRI 4 (lines 7+8)
7. ISDN BRI 3 (lines 5+6)
8. ISDN BRI 2 (lines 3+4)
9. ISDN BRI 1 (lines 1+2)

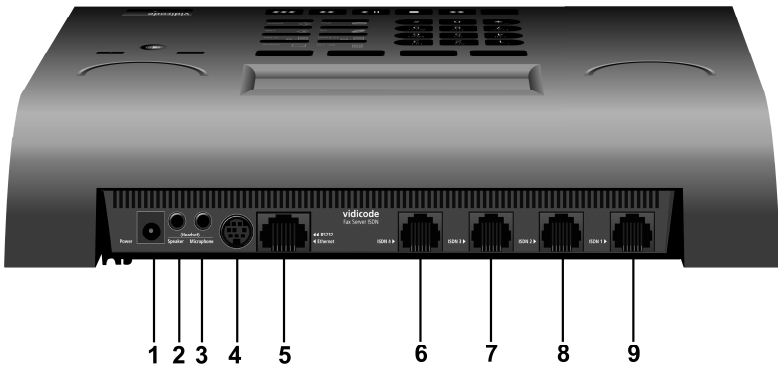

Connections Fax Server ISDN – 19" model

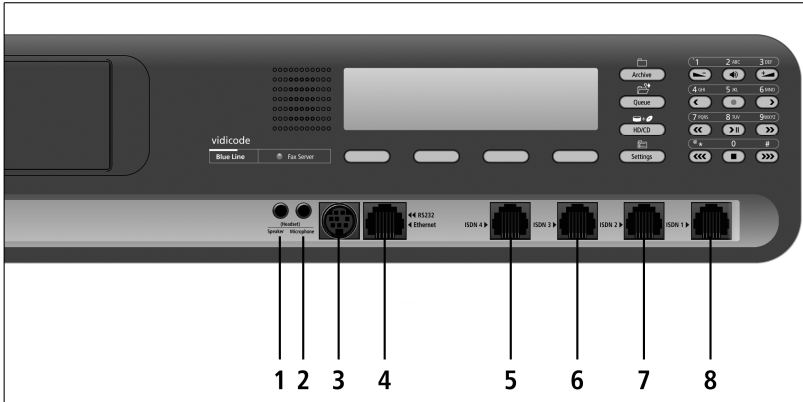

1. Loudspeaker
2. Microphone
3. RS 232 serial connection
4. Ethernet/LAN
5. ISDN BRI 4 (lines 7+8)
6. ISDN BRI 3 (lines 5+6)
7. ISDN BRI 2 (lines 3+4)
8. ISDN BRI 1 (lines 1+2)



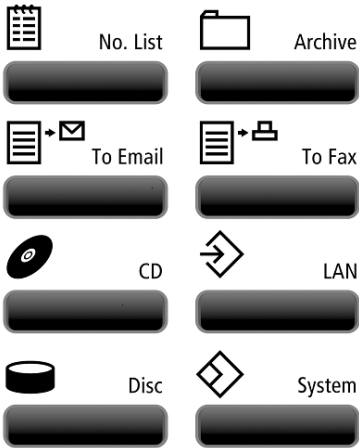



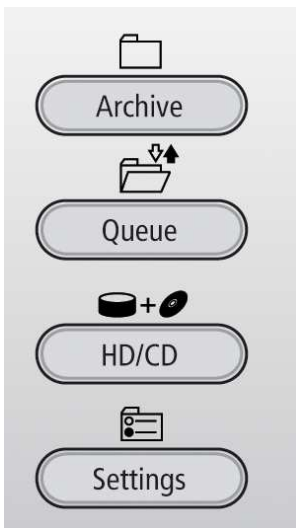

Function-keys on desktop model



Function-keys on 19" model



Alfa-numerical functions

Numerical keys	Function				
	Press the relevant key repeatedly or hold down:				
	1x	2x	3x	4x	5x
	1	.	:	'	;
	A	B	C	2	!
	D	E	F	3	%
	G	H	I	4	^
	J	K	L	5	\$
	M	N	O	6	@
	P	Q	R	5	7
	T	U	V	8	&
	W	X	Y	Z	9
	*	@	/	<	>
	#	()	[]
Recorder keys	Function				
	Toggle uppercase and lowercase				
	Forward				
	Backward				

Care and Maintenance



Keep the Fax Server dry. If it gets wet, wipe it dry immediately. Liquids might contain minerals that can corrode the electronic circuits.



Use and store the Fax Server only in normal temperature environments. Temperature extremes can shorten the life of electronic devices and distort or melt plastic parts.



Keep the Fax Server away from excessive dust and dirt that can cause premature wear of parts.



Do not use harsh chemicals, cleaning solvents or strong detergents to clean the Fax Server.

Contents

1	Introduction	15
2	Unpacking and installation.....	17
2.1	What is in the box	17
2.2	Connecting to power	19
2.3	Connecting to E1 primary rate ISDN.....	20
2.4	Connecting to S0 Basic Rate ISDN.....	22
2.4.1	Without other equipment in Stand Alone mode.....	24
2.4.2	With other equipment in Stand Alone mode.....	25
2.4.3	With other equipment in Pass Through mode.....	26
3	Configuration and operation	27
3.1	Operation basics	27
3.2	Frequently used key indicators	28
3.3	Save Changes	28
4	System settings.....	30
4.1	Fax ID.....	30
4.2	Top text	31
4.3	Dial prefix	32
4.4	Stand Alone Mode.....	32
4.5	Connection (BRI only).....	33
4.6	Total Lines (BRI only).....	33
4.7	Max. Fax Lines.....	34
4.8	Max. Rx Fax Lines.....	34
4.9	Max. Tx Fax Lines.....	34
4.10	Tx Retries.....	35
4.11	Tx Retry Time	35
4.12	Tx Answer Timeout.....	35
4.13	Tx Start Time	36
4.14	Tx Stop Time	36
4.15	Fax to printer	36
4.16	Protect the Fax Server with a Password	37
4.17	Remove Password protection.....	37
4.18	Set the Clock	38
4.19	Set the Language.....	39
5	LAN settings	40
5.1	FTP user	40
5.2	FTP password	41

5.3	FTP port	41
5.4	DHCP server	42
5.5	IP address	43
5.6	IP subnet mask	43
5.7	Gateway	44
5.8	IP name	44
5.9	Email address	45
5.10	Reply address	46
5.11	SMTP server IP address	46
5.12	SMTP server port	47
5.13	SMTP Login	48
5.14	Domain name	48
5.15	DNS server	49
5.16	Printer address	50
5.17	Printer port	50
5.18	Printer queue	51
5.19	NTP Server	51
5.20	NTP Server Port	52
5.21	GMT correction	53
5.22	Telnet	53
5.23	Service timer	54
6	The Internal Number List and how faxes are answered	55
	6.1.1 Add a new number to the internal number list	56
	6.1.2 Delete a number from the fax number list	57
7	Managing Users.....	59
7.1	Introduction	59
7.2	Installation of Fax Server Setup	60
7.3	Software updates	60
7.4	Setting up a Fax Server	61
7.5	The user list	63
7.6	Create a new user	63
7.7	Edit a user profile	64
8	In service operation.....	66
8.1	Fax Archive	67
	8.1.1 Received faxes	67
	8.1.2 Sent faxes	68
8.2	Email queue	70
	8.2.1 Send an Email again	70
8.3	Fax Queue	71

8.3.1	Send a fax again.....	71
8.4	Disk info.....	71
9	Acknowledgements.....	73
9.1	Guarantee.....	73
9.2	Liability.....	73
10	INDEX.....	75

1 Introduction

The Fax Server is a system with ISDN and Ethernet interfaces. It offers services that can be compared with what the PBX does for voice calls. On top of that it will record and archive all fax communication. The Fax Server has the following functions:

Receiving faxes

Incoming calls on the fax numbers are answered by the Fax Server. Received faxes are stored on the internal Drive of the Fax Server. PC's have access to the Fax Server via the LAN and can view and print all faxes from the internal Drive of the Fax Server.

Distribution of faxes via Email

The preferred method to receive faxes for most people is as internal email. Dependant on the fax Number that the Fax Server has answered to it will forward the fax to the email address that belongs to this number.

Receiving faxes on paper

If required all received faxes can be printed out on a network printer.

Sending faxes

Faxes can be sent from any computer on the network that has SendFax software installed. On the PC the SendFax software behaves as a printer. SendFax software transfers the file over the network to the Fax Server which in turn takes care of the actual fax transmission. All sent faxes remain stored on the Fax Server and can be accessed via the LAN at any time.

Archiving faxes

The most important function of the Fax Server is to give access to all fax correspondence that took place since it was installed. The Fax Server Access System software supplied is the best tool to access the faxes because they are presented as a database.

Several models

There are two models of ISDN Fax Servers. This has to do with the different ISDN line types that exist. The types are primary rate (PRI) and basic rate (BRI).

The interface to the network is called E1 for primary rate and S0 for basic rate.

Basic rate lines carry 2 telephone channels. Primary rate lines can carry a variable number of channels that the user has subscribed to with a maximum of 30.

The models for basic rate and for primary rate are different because of the interface to the telephone network.

The model for primary rate can send and receive on up to 16 channels simultaneously. It has only one line port.

The model for basic rate is available for 2 lines and 4 lines and can work on 4 or 8 channels simultaneously.

Identical operation

The differences between the Fax Servers for basic rate and for primary rate are only small. In this manual they are treated as one product and differences, if they exist, are mentioned only when needed.

2 Unpacking and installation

The various models of the Fax Servers for ISDN are:

- Fax Server ISDN PRI
- Fax Server ISDN BRI – 2 lines
- Fax Server ISDN BRI – 4 lines

There are several options available:

- Fax channels
 - from 1 to 16 channels on a ISDN PRI
 - from 1 to 4 channels on a ISDN BRI – 2 lines
 - from 1 to 8 channels on a ISDN BRI – 4 lines
- frame for 19" rack mounting

The minimal configuration is a Fax Server with at least 1 channel.

2.1 What is in the box

The Fax Server ISDN PRI desktop model comes with the following parts:

- Mains power supply adapter and cable.
- two 8-wire cables with RJ45 connectors
- CD with software
- This manual

The Fax Server ISDN PRI 19" model comes with the following parts:

- Mains cable.
- two 8-wire cables with RJ45 connectors
- CD with software
- This manual

The Fax Server ISDN (BRI) desktop model comes with the following parts:

- Mains power supply adapter and cable.
- Per line a cable kit that contains a short and a long 8-wire cable with RJ45 connectors (4 cables or 8 cables in total)
- Per line a T-adapter (2 or 4)
- CD with software
- This manual

The Fax Server ISDN (BRI) 19" model comes with the following parts:

- Mains cable.
- Per line a cable kit that contains a short and a long 8-wire cable with RJ45 connectors (4 cables or 8 cables in total)
- Per line a T-adapter (2 or 4)
- CD with software
- This manual

Please note: For some countries we do not supply a mains cable with our product (Australia, Switzerland). The reason for this is that the cable with the correct mains plug is not available in the country of manufacture.

2.2 Connecting to power

On the desktop model

The Fax Server is powered through an external power adapter. It does not have an On/Off switch; the Fax Server is turned on by connecting the power supply.



On the 19" model

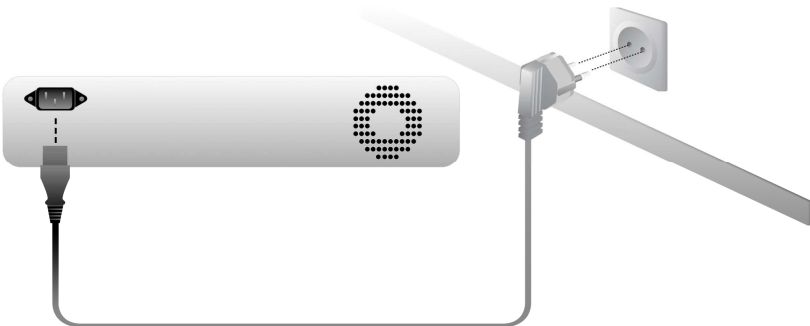

The Fax Server is powered through a line cord. The power supply is internal. The unit does not have an On/Off switch; the Fax Server is turned on by connecting the mains cable.

2.3 Connecting to E1 primary rate ISDN

This only applies to the model for ISDN primary rate.

The Fax Server PRI is connected in series with the PBX. With the Fax Server PRI you have received a cable with two RJ45 connectors. This cable is used to connect the Fax Server PRI to the wall socket. The existing cable can be used to connect the Fax Server PRI to the PBX as is shown in the figure below.

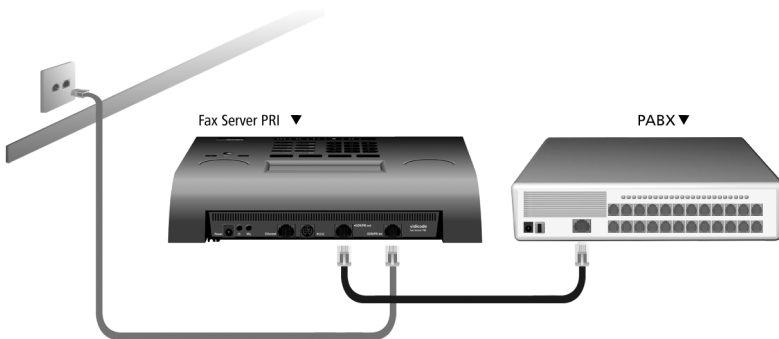

It is possible that you do not want to connect the PBX together with the Fax Server on one line because you want to use the line for faxing only. In this case the PBX and the connection to it are not there.

It is also possible that you want to use all 30 channels of the E1 line for faxing. In this case a second Fax Server PRI can be connected in place of the PBX.

The figures below are examples of a possible setup of the Fax Server PRI.

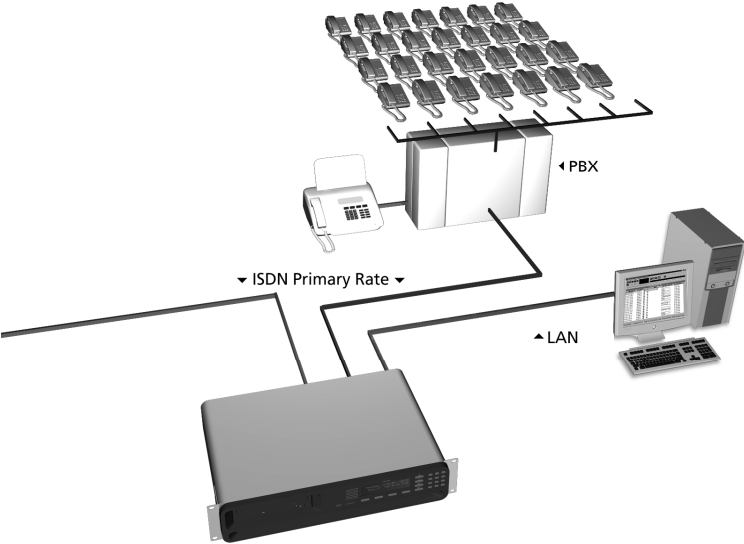
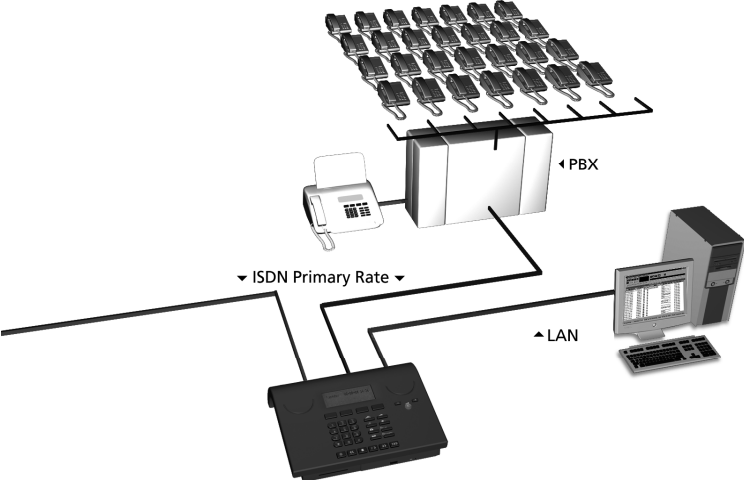

2.4 Connecting to S0 Basic Rate ISDN

There are three ways to use a Fax Server ISDN Basic Rate:

- Stand alone on lines that are used for the Fax Server only.
- Together with other equipment such as the PBX

You must always use the supplied T-splitters to connect to the ISDN S0 line. The T-splitter is marked that it is made for a "Call Recorder". The reason is that the T-splitter was indeed originally made for the Call Recorder, another product that has the same interface to the network.

The figures below are examples of a possible setup of the Fax Server ISDN Basic Rate.

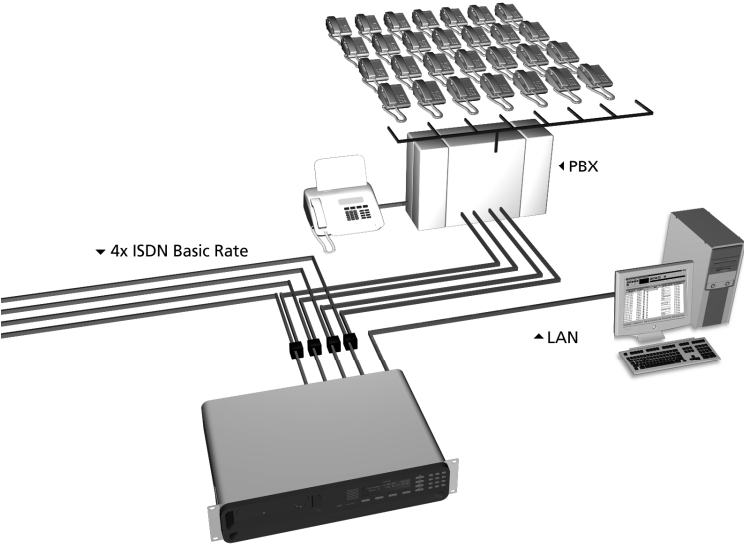
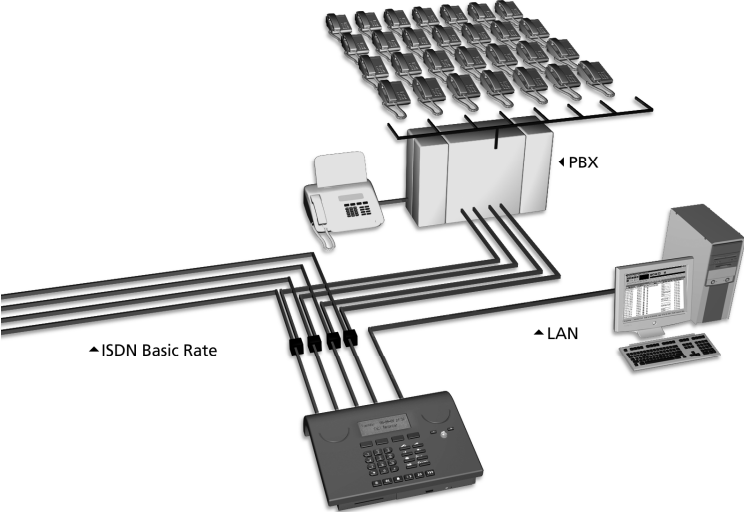

2.4.1 Without other equipment in Stand Alone mode

This is how to connect to the ISDN S0 bus if you use the line only for the Fax Server. This applies to point-to-point and point-to-multipoint lines.

Use the long cable supplied in the box to connect to the TE port of the T-adapter and use the short cable to connect the port ISDN of the T-adapter to Port 1 to 4 of the Fax Server.

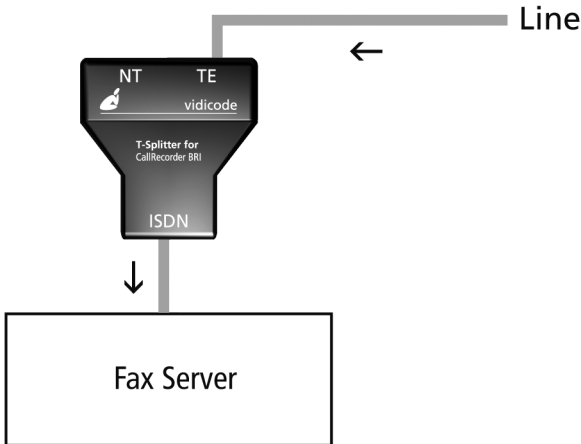

2.4.2 With other equipment in Stand Alone mode

This only applies to point-to-multipoint ISDN lines. If you doubt whether the line that you have is point to multi point select the next option.

This way of connecting has a small advantage over the next option. You do not disconnect other equipment while connecting the Fax Server.

The connection is the same as above: Use the long cable supplied in the box to connect to the TE port of the T-splitter and use the short cable to connect the port ISDN of the T-adaptor to Port 1 to 4 of the Fax Server.

This is the classic way to connect ISDN equipment to point to multi point lines.

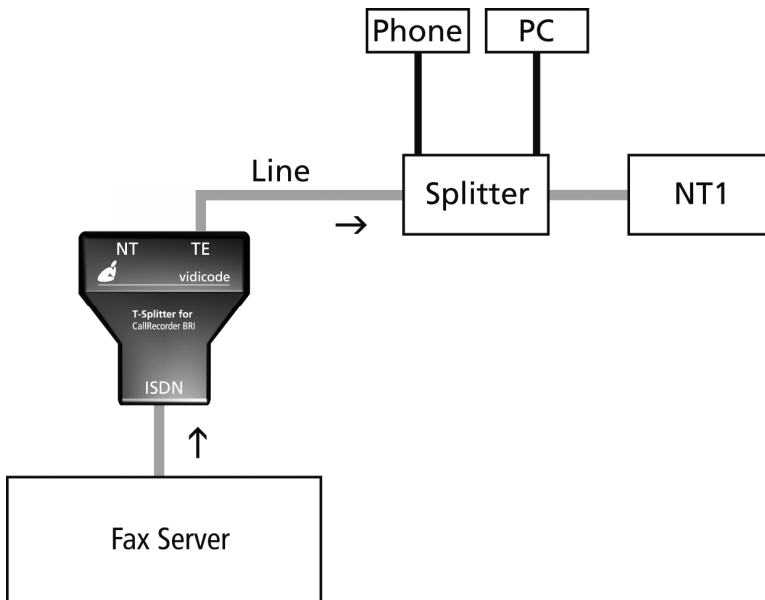

2.4.3 With other equipment in Pass Through mode

This is the most often used method to connect the Fax Server on ISDN basic rate. We call this "pass through mode". The difference is that the Fax Server can see and record all communication of connected terminal equipment. This is used for recording fax transmissions of other fax machines.

In this case the connection again is the same as above, but all terminal equipment (TE) that must be recorded is connected to the TE port of the adapter. Usually this will be the PBX with one or more fax machines connected to it.

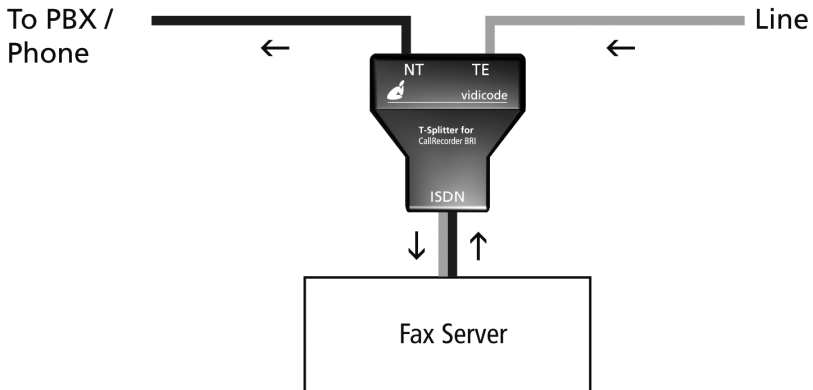

3 Configuration and operation

After you have connected the hardware it is time to configure and use the Fax Server. This chapter explains you how the user interface works. In the following chapters we guide you with the configuration. You must:

- On the keyboard of the Fax Server, go through the system settings and make changes if required **and**
- On the keyboard of the Fax Server, go through the network settings so the Fax Server will fit in with your network **and**
- On the keyboard of the Fax Server, edit the number list to enable the fax numbers and attach email addresses to them **or**
- On the PC of the systems manager, arrange the user profiles and user access to the Fax Server

3.1 Operation basics

The Fax Server has a common menu driven user interface. Most functions and operations are initiated by pressing a function key followed by a sequence of menu keys of which the function is determined by the text in the display. The use of function keys and menu keys is as follows:

Function keys

The most frequently used functions of the Fax Server have been grouped in the function keys. Throughout the entire manual, symbols representing the function keys are used to indicate the function key corresponding to the described function.

Menu keys

After pressing a function key the available functions are assigned to the four menu keys. The operation of the menu keys is determined by the text in the display right above the corresponding key. Throughout the entire manual figures representing the display with or without the menu keys are used to show the required action corresponding to the described feature.

Example:

Monday	16-11-04	15:51
Busy 0	Fax Rx/Tx 0/0	
NEXT	MENU	STOP



When you are instructed to press the **MENU** key in the text it means you are instructed to press the grey key below the text **MENU** in order to open the System setting menu.

3.2 Frequently used key indicators

The following menu key functions are consistently used throughout the manual.

MENU in the display indicates the presence of an underlying menu

Press **MENU** to open the underlying menu

NEXT in the display indicates the presence of more menu items

Press **NEXT** to jump to the following menu item

BACK in the display indicates the presence of an embracing menu

Press **BACK** to return to the embracing menu

STOP in the display indicates the absence of an embracing menu

Press **STOP** to return to operating mode of the Fax Server

CHANGE will toggle the item in the display between "On" and "Off"

In some cases **CHANGE** is used to increase or decrease a value.

3.3 Save Changes

After making settings the user is forced to press **YES** or **NO** before returning to operating mode. Press **STOP** in the menu and the display will show:

Save Changes?		
YES	NO	CANCEL

YES returns the Fax Server to normal use with changed settings

NO returns the Fax Server to normal use without changed settings

CANCEL returns to the settings

4 System settings

When you have connected the Fax Server you can configure it. This chapter is about the system settings. Enter the system settings as follows.

On the desktop model:

- Press the  **System Settings** key.

On the 19" model:

- Press the  key.
- Press **System** to move to the menu.

From here on desktop model and 19" are the same. A sequence of system settings will need to be passed. Every item will have at least three options:

- Press **NEXT** to move on to the next menu item.
- Press **CHANGE** to enter the value or property of the menu item.
- Press **STOP** to exit the menu.

Press **NEXT** repeatedly to scroll through the menu items. The following sequence of menu items will appear:

4.1 Fax ID

The Fax ID is the identification of the fax machine. When a fax is transmitted between two fax machines, they both negotiate their Fax ID's. The Fax ID is also displayed in the top line of the fax. The Fax ID that you must enter here is just the default Fax ID that applies when there are no matching user configurations. When the Fax Server is sending or receiving on behalf of one of the users, it will use the Fax ID for that user.

Fax-ID: NEXT CHANGE STOP

Set the Fax ID.

- Press **CHANGE** to enter the Fax ID.

Fax-Id: █ STORE CANCEL
--

Enter the Fax ID.

- Press **STORE** to save the Fax ID.
- Press **NEXT** to move on to the next menu item.

It is a good practice that a Fax ID is the number that the fax can be reached on. However text can also be entered here.

4.2 Top text

The top text is the text that is printed as the top line of the fax. Usually this will be the name of the person or company.

Top Text: NEXT CHANGE STOP

Set the Top text.

- Press **CHANGE** to enter the Top text.

Top Text: █ STORE CANCEL
--

Enter the Top text.

- Press **STORE** to save the Top text.
- Press **NEXT** to move on to the next menu item.

4.3 Dial prefix

The dial prefix is a standard number sequence that must be dialed before an external number can be reached. When a Fax Server is connected to an internal extension of a digital PBX a common prefix would be "0".

It can also be used to route faxes to the most economical network provider, that sometimes is not the same provider as for telephony because fax transmissions tend to be shorter then telephone calls.



Set the dial prefix.

- Press **CHANGE** to enter the Prefix.

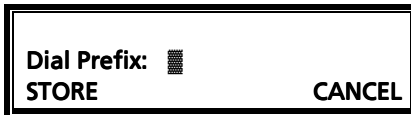

Enter the dial prefix.

- Press **STORE** to save the dial prefix.
- Press **NEXT** to move on to the next menu item.

4.4 Stand Alone Mode

Usually the Fax Server is connected to the line in series with a PBX (**Pass Through Mode**). If this is not the case (Fax Server is the only device on the line) the **Stand Alone Mode** setting has to be turned **On**.

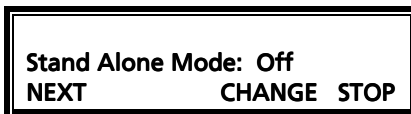

Set the Stand Alone Mode.

- Press **CHANGE** to enable Stand Alone Mode.

Please Note: If the Fax Server is in series with a PBX Stand Alone Mode **must** be turned **Off**.

Stand Alone Mode: On
NEXT CHANGE STOP

Set the Stand Alone Mode.

- Press **STORE** to save the Stand Alone Mode.
- Press **NEXT** to move on to the next menu item.

4.5 Connection (BRI only)

This option only applies to ISDN Basic Rate. There are two configurations of Euro ISDN basic rate lines, called Point-to-Point and Point-to-Multipoint. Because the protocol is different the Fax Server must know. In case of doubt you must call your telephony provider.

Connection: Multipoint
NEXT CHANGE STOP

Set the Connection type.

- Press **CHANGE** to alter the setting.

Connection: Point-to-Point
NEXT CHANGE STOP

Set the Connection type.

- Press **STORE** to save the connection type.
- Press **NEXT** to move on to the next menu item.

4.6 Total Lines (BRI only)

The Total Lines property determines the number of lines that can be occupied by the Fax Server BRI counted from port 1 to 8 for sending. Lines are counted from port ISDN 1 to ISDN 4. This property is used to keep ISDN BRI lines completely free of outgoing faxes.

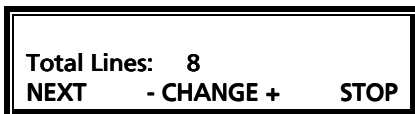

Set the Maximum number of Fax lines.

- Press **+ or -** to change the number of lines.
- Press **NEXT** to move on to the next menu item.

4.7 Max. Fax Lines

The Maximum Fax Lines property determines the number of lines that can be occupied by the Fax Server. This property is used to prevent the Fax Server to seize too many lines and to guarantee that a fixed number of lines is available for the PBX.

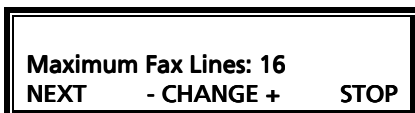

Set the Maximum number of Fax lines.

- Press **+ or -** to change the number of lines.
- Press **NEXT** to move on to the next menu item.

4.8 Max. Rx Fax Lines

The maximum Rx Fax Lines fixes the maximum number of lines that can be used by the Fax Server for Fax reception.

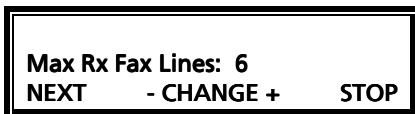

Set the Maximum Rx Fax Lines number.

- Press **+ or -** to change the number of lines.
- Press **NEXT** to move on to the next menu item.

4.9 Max. Tx Fax Lines

The maximum Tx Fax Lines fixes the maximum number of lines that can be used by the Fax Server for Fax transmission.

Max Tx Fax Lines: 6 NEXT - CHANGE + STOP

Set the Maximum Tx Fax Lines number.

- Press **+ or -** to change the number of lines.
- Press **NEXT** to move on to the next menu item.

4.10 Tx Retries

Tx Retries determines the number of attempts to send a fax.

Tx Retries: 5 NEXT - CHANGE + STOP

Set the number of attempts.

- Press **+ or -** to change the number of attempts.
- Press **NEXT** to move on to the next menu item.

4.11 Tx Retry Time

The TX Send Retry Time determines the interval between the fax transmission attempts.

Tx Retry Time: 120s NEXT - CHANGE + STOP

Set the Retry Time.

- Press **+ or -** to change the Retry Time.
- Press **NEXT** to move on to the next menu item.

4.12 Tx Answer Timeout

The Tx Answer Timeout time determines the time the Fax Server will wait for the remote fax machine to answer the call.



Set the Tx Answer Timeout.

- Press **+ or -** to change the Tx Answer Timeout.
- Press **NEXT** to move on to the next menu item.

4.13 Tx Start Time

With Tx Start Time a time of the day can be set for the Fax Server to start sending the faxes in the Fax queue. **Please note:** Priority will always be sent at once and not wait for the start time.



Set the Tx Start Time.

- Press **+ or -** to change the Tx Start Time or turn **Off**.
- Press **NEXT** to move on to the next menu item.

4.14 Tx Stop Time

In conjunction with the **Tx Start Time** the Tx Stop Time sets a limit to the time the Fax Server is given to handle the Fax queue. If Tx Start Time is set to **Off** the Tx Stop Time will not appear.



Set the Tx Stop Time.

- Press **+ or -** to change the Tx Stop Time.
- Press **NEXT** to move on to the next menu item.

4.15 Fax to printer

Fax to Printer allows for automatic printing of faxes. Network setting of the printer are described in § 5.16.



Set Fax to Printer.

- Press **CHANGE** to select **All**, **Rx Only**, **Tx Only** or **Off**.
- Press **NEXT** to move on to the next menu item.

4.16 Protect the Fax Server with a Password

The Fax Server can be protected with a password against unauthorized use. When password protection has been enabled all operations are blocked before the correct password has been entered.



Setting the Password.

- Press **CHANGE** enable password protection
- The display will then prompt for a password.



Enter a password.

- Press **STORE** to enable the entered password.
- Press **STOP** to exit the menu.

From this point on you will be prompted for the password before entering the menus.

4.17 Remove Password protection

- **On the desktop model** press the  **System** button (if you are not already in the menu).



- On the 19" model press the **Settings** key and then press **SYSTEM**.
- Enter the password and press **CONTINUE**.
- Press **NEXT** 11 x.



Disable the Password.

- Press **CHANGE** to disable the password.
- Press **STOP** to save and exit the menu.

The password protection has now been disabled.

4.18 Set the Clock

The clock can be set manually, or if available on the network, **NTP** can be enabled to retrieve the time from a network server.

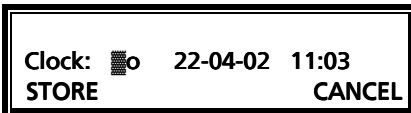
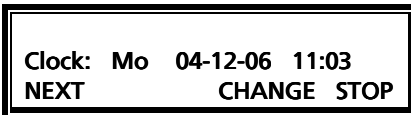

Setting the clock.

- Press **CHANGE** to change the setting of the clock.
- Press key's 1-7 to change the day of the week.

The default date and time format is DD-MM-YY and HH:MM (when American has been set as language the format is changed to MM-DD-YY). Use the arrowed keys to move the blinking character left and right.

- Press softkey **STORE** to store the changes or press softkey **CANCEL** to return to previous values.

4.19 Set the Language

You can select the language of your choice. Several languages are available in the Fax Server. Selecting "American" will also influence the date and time format used.

Language: English CHANGE STOP

Setting the Language.

- Press **CHANGE** to select the preferred language.
- Press **STOP** to save and exit the menu.

5 LAN settings

Enter the LAN settings as follows.

On the desktop model:

- Press the  **LAN** key.

On the 19" model:

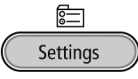
- Press the  **Settings** key.
- Press **LAN** to move to the LAN settings menu's

A sequence of LAN settings will appear. Every item will have at least three options:

- Press **NEXT** to move on to the next menu item.
- Press **CHANGE** to enter or change the value or property of the menu item.
- Press **STOP** to exit the menu.

Press **NEXT** repeatedly to scroll through the menu items. The following sequence of menu items will appear:

5.1 FTP user

The FTP user is the administrator user name of the Fax Server. It can be used in the Fax Server Access System and Send Fax to log on to the Fax Server. The administrator with this username and password has all the available authorities.

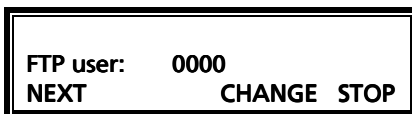

Set the FTP user name.

- Press **CHANGE** to change the FTP user name.

FTP user: █	
STORE	CANCEL

Enter the FTP user name.

Use the numerical keys to enter the FTP user name.

- Press **STORE** to save the FTP user name.
- Press **NEXT** to move on to the next menu item.

5.2 FTP password

The FTP password of the Fax Server is the password that goes with the FTP administrator user name of the Fax Server.

FTP pwd: 0000		
NEXT	CHANGE	STOP

Set the FTP password.

- Press **CHANGE** to change the FTP password.

FTP pwd: █		
NEXT	CHANGE	STOP

Enter the FTP password.

Use the numerical keys to enter the FTP password.

- Press **STORE** to save the FTP password.
- Press **NEXT** to move on to the next menu item.

5.3 FTP port

FTP port is the port number through which the Fax Server Access System and Send Fax log on to the Fax Server. The FTP server port is default set to 21, as is the setting of the port number in the Fax Server Access System and Send Fax. If there is no direct reason to change the FTP server port it is best left unchanged.

FTP port:	21
NEXT	CHANGE STOP

Set the FTP -server port number.

- Press **CHANGE** to change the FTP server port number.

FTP port:	█
STORE	CANCEL

Enter the FTP server port number.

Use the numerical keys to enter the FTP server port number.

- Press **STORE** to save the FTP server port number.
- Press **NEXT** to move on to the next menu item.

5.4 DHCP server

In case a DHCP server is used on the network the use of the DHCP server must be enabled. In case it is not used it must be disabled.

Use DHCP server: No
NEXT CHANGE STOP

Use of the DHCP server

- Press **CHANGE** to enable DHCP server.

Use DHCP server: Yes
NEXT CHANGE STOP

Use of the DHCP server enabled

- Press **NEXT** to save and move on to the next menu item.

5.5 IP address

As part of the network the Fax Server requires an IP address. In case a DHCP server is used (see previous item) the DHCP server will assign the Fax Server an IP address. In case a DHCP server is not used a static IP address must be given to the Fax Server.

IP addr: 0.0.0.0 NEXT CHANGE STOP

Set the IP address of the Fax Server.

- Press **CHANGE** to enter the IP address of the Fax Server.

IP addr: 00.000.000.000 STORE CANCEL
--

Enter the IP address of the Fax Server.

Use the numerical keys to enter the IP address of the Fax Server.

- Press **STORE** to save the IP address of the Fax Server.
- Press **NEXT** to move on to the next menu item.

5.6 IP subnet mask

The IP subnet mask is used by the Fax Server if access outside the network is required. In this case the gateway will need to be entered as well. In case the used SMTP server is not on the local network the IP mask and gateway must be entered.

IP mask: 255.255.255.000 NEXT CHANGE STOP

Set the IP subnet mask of the Fax Server.

- Press **CHANGE** to change the IP subnet mask of the Fax Server.

IP mask: 55.255.255.000 STORE CANCEL
--

Enter the IP subnet mask of the Fax Server.

Use the numerical keys to enter the IP subnet mask of the Fax Server.

- Press **STORE** to save the IP subnet mask of the Fax Server.
- Press **NEXT** to move on to the next menu item.

5.7 Gateway

The Gateway is used by the Fax Server if access from outside the network is required. If so the Gateway and the IP subnet mask will need to be entered. For instance, if the used SMTP server is not on the local network the IP mask and gateway are required.

Gateway: 0.0.0.0 NEXT CHANGE STOP
--

Set the Gateway of the Fax Server.

- Press **CHANGE** to enter the Gateway of the Fax Server.

Gateway: 00.000.000.000 STORE CANCEL
--

Enter the Gateway of the Fax Server.

Use the numerical keys to enter the Gateway of the Fax Server.

- Press **STORE** to save the Gateway of the Fax Server.
- Press **NEXT** to move on to the next menu item.

5.8 IP name

Aside from the IP address the Fax Server can also be addressed by an IP name if this function is supported by your DNS server.

IP name: IPFax0001
NEXT CHANGE STOP

Set an IP name for the Fax Server.

- Press **CHANGE** to enter an IP name for the Fax Server.

IP name: IPFax0001
STORE << CLEAR CANCEL

Enter an IP name for the Fax Server.

Use the numerical keys to enter an IP name for the Fax Server.

- Press **STORE** to save the IP name of the Fax Server.
- Press **NEXT** to move on to the next menu item.

5.9 Email address

The Fax Server has extensive Email capabilities. Received faxes will be sent to the email address of the owner of the fax number. Sent faxes will be confirmed by email to the sender.

There is however, a default email address that will be used when no other Email address is known. This might be the email address of the person who is responsible for the Fax Server. The email address to be filled in here is this default email address.

Email:
NEXT CHANGE STOP

Set the Email address.

- Press **CHANGE** to enter an Email address.

Email: █ STORE	CANCEL
---------------------------------	---------------

Enter the Email address.

Use the numerical keys to enter the Email address.

- Press **STORE** to save the Email address.
- Press **NEXT** to move on to the next menu item.

Selection of faxes for distribution via Email can also take place according to remote Fax ID.

5.10 Reply address

Because the Fax Server cannot receive Email the Emails sent by the Fax Server require another reply address.

Reply: NEXT	CHANGE STOP
------------------------------	--------------------

Set the Email reply address.

- Press **CHANGE** to enter the Email reply address.

Reply: █ STORE	CANCEL
---------------------------------	---------------

Enter the Email reply address.

Use the numerical keys to enter the Email reply address.

- Press **STORE** to save the Email reply address.
- Press **NEXT** to move on to the next menu item.

5.11 SMTP server IP address

The Fax Server uses the IP address of the SMTP server to send Email. In case a local SMTP server is used the IP number can be entered directly. In

case of an SMTP server outside the network both the **Gateway** and the **Subnet Mask** must be set as well.

SMTP srv: 0.0.0.0 NEXT CHANGE STOP

Set the IP address of the SMTP server.

- Press **CHANGE** to enter the IP address of the SMTP server.

SMTP-srv: 00.000.000.000 STORE CANCEL
--

Enter the IP address of the SMTP server.

Use the numerical keys to enter the IP address of the SMTP server. Both an IP number or IP name are allowed. In case an IP name is used the DNS server needs to be configured.

- Press **STORE** to save the IP address of the SMTP server.
- Press **NEXT** to move on to the next menu item.

5.12 SMTP server port

SMTP server port is the port number through which the Fax Server connection is to be made with the SMTP server. The SMTP-server port of the Fax Server is default set to 25. Do not change the SMTP-server port number when this value is not explicitly changed in the SMTP-server.

SMTP-server port: 25 NEXT CHANGE STOP
--

Set the SMTP-server port number.

- Press **CHANGE** to change the SMTP-server port number.

SMTP-server port: █
STORE CANCEL

Enter the SMTP-server port number.

Use the numerical keys to enter the SMTP-server port number.

- Press **STORE** to save the SMTP-server port number.
- Press **NEXT** to move on to the next menu item.

5.13 SMTP Login

Sometimes SMTP-servers are set up to require a login. In this case SMTP Login should be enabled. **Note:** When SMTP Login is enabled the next questions in the menu will ask for SMTP User name and Password.

SMTP Login: No
NEXT CHANGE STOP

Enable SMTP Login.

- Press **CHANGE** to enable SMTP Login
- Press **NEXT** to save and move on to the next menu item.

When SMTP Login is enabled, the next two items in the menu will be:

SMTP user and **SMTP password**

5.14 Domain name

This is the domain name of the SMTP-server. In case the SMTP-server is on the network the network domain is required. In case the SMTP-server is outside the network the domain name of the SMTP-server is required. Contact your provider for more information. Usually the IP-address of the SMTP-server is enough and the domain name is left empty.

Domain: brifax.nl
NEXT CHANGE STOP

Set the domain of the SMTP-server.

- Press **CHANGE** to enter the domain of the SMTP-server.

Domain: brifax.nl
STORE << CLEAR CANCEL

Enter the domain of the SMTP-server.

Use the numerical keys to enter the domain of the SMTP-server.

- Press **STORE** to save the domain of the SMTP-server.
- Press **NEXT** to move on to the next menu item.

5.15 DNS server

In case an IP name has been configured for your SMTP-server you must also give the IP number of the Domain Name Server.

DNS srv: 0.0.0.0
NEXT CHANGE STOP

Set the DNS server

- Press **CHANGE** to enter the DNS server.

DNS srv: 00.000.000.000
STORE CANCEL

Enter the DNS server

Use the numerical keys to enter the DNS server.

- Press **STORE** to save the DNS server.
- Press **NEXT** to save and move on to the next menu item.

5.16 Printer address

In case automatic printing has been enabled a printer address has to be specified.

Printer addr.: 0.0.0.0 NEXT CHANGE STOP

Set the Printer address.

- Press **CHANGE** to enter the Printer address.

Printer addr: 0.0.0.0 STORE << CLEAR CANCEL

Enter the Printer address

Use the numerical keys to enter the Printer address.

- Press **STORE** to save the Printer address.
- Press **NEXT** to save and move on to the next menu item.

5.17 Printer port

The Printer port is the port number through which the Fax Server connection is to be made with the printer.

Printer port: 515 NEXT CHANGE STOP

Set the Printer port

- Press **CHANGE** to enter the Printer port.



Enter the the Printer port

Use the numerical keys to enter the Printer port.

- Press **STORE** to save the Printer port.
- Press **NEXT** to save and move on to the next menu item.

5.18 Printer queue

In case automatic printing has been enabled a network printer queue name has to be specified.



Set the Printer queue

- Press **CHANGE** to enter the Printer queue.



Enter the Printer queue

Use the numerical keys to enter the Printer queue.

- Press **STORE** to save the Printer queue.
- Press **NEXT** to save and move on to the next menu item.

5.19 NTP Server

Network Time Server refers to the IP address of the Network Time Server. Network Time Server is used to synchronize the time of the Fax Server with the time on the Network Time Server.

NTP srv: 0.0.0.0
NEXT CHANGE STOP

Set the IP address of the NTP server.

- Press **CHANGE** to enter the IP address of the NTP server.

NTP srv: 00.000.000.000
STORE CANCEL

Enter the IP address of the NTP server.

Use the numerical keys to enter the IP address of the NTP server.

- Press **STORE** to save the IP address of the NTP server.
- Press **NEXT** to save and to move on to the next menu item.

5.20 NTP Server Port

NTP server port is the port number through which the Fax Server connects to the Network Time Server. The NTP server port is default set to 123, as is the setting of the port number in most NTP servers. If there is no direct reason to change the NTP server port it is best left unchanged.

NTP server port: 123
NEXT CHANGE STOP

Set the NTP server port number.

- Press **CHANGE** to change the NTP server port number.

NTP server port: 123
STORE CANCEL

Enter the NTP server port number.

Use the numerical keys to enter the NTP server port number.

- Press **STORE** to save the NTP server port number.
- Press **NEXT** to save and to move on to the next menu item.

5.21 GMT correction

GMT correction property is used to identify the time zone. NTP server normally issues GMT. GMT correction can be set in half hours from - 15:00 to + 15:00.

GMT correction: 00:00 NEXT CHANGE STOP
--

Send Start Time.

- Press **CHANGE** to set GMT correction. Keep pressing **CHANGE** to increase the correction. It will start with + 1:00, keep pressing **CHANGE** to increase. After + 15:00 there will appear - 15:00.
- Press **NEXT** to save and move on to the next menu item.

GMT correction refers to Winter time. Summer time and Winter time are corrected automatically.

5.22 Telnet

Telnet can be used to log on to the Fax Server and configure the Fax Server from your PC. If required contact your supplier for more details.

TelNet active: No NEXT CHANGE STOP
--

Enable TelNet.

- Press **CHANGE** to enable TelNet.

TelNet active: Yes NEXT CHANGE STOP

TelNet enabled.

- Press **NEXT** to save and move on to the next menu item.

5.23 Service timer

The Service timer determines the performance of the network connection. Default the Service timer is set to Automatic. Changing the setting should only be done when advised by a service engineer to solve problems.

Service timer: Auto CHANGE STOP
--

Set the Service timer

- Press **CHANGE** to change the Service timer.

The following settings are available:

S1-S5, F1-F4 and U1-U4.

Where **S** stands for Slow, **F** for Fast and **U** for Ultra fast.

The Service Timer is the last item in the LAN settings menu.

- Press **STOP** to exit the LAN menu.

6 The Internal Number List and how faxes are answered

The next step in the configuration is to fill in the **Internal (Fax) Number List**.

Normally you will have to tell a Fax Server what numbers it should answer. On an ISDN line bundle, PRI or BRI, there are several or many numbers available. The internal fax number list is the list of numbers that the Fax Server will answer to.

However, there is an exception to this rule: if the Fax Server is configured to be the only machine on the line(s), then it will answer all incoming calls. This will when:

- A Fax Server for ISDN BRI is stand alone on a point to point line.
- A Fax Server for ISDN PRI is in stand alone mode (a PRI line is always "point to point")

In the above two situations the Fax Server will receive faxes and handle them as in the default settings given by you as LAN settings or system settings.

In all other cases the Internal Number List will be applied.

The Internal Number list is nothing more than a list of numbers that the Fax Server will answer to. These numbers must be supplied to you by the telephony provider. In some instances you get many of numbers for one line or bundle of lines already when you subscribe. In other cases you will have to order more numbers from your provider. In any case the idea is that everyone in your office who needs a direct fax number will get that, just like he has his direct phone number.

To every number in the list an email address should be added. Faxes received on the fax number are forwarded by email to the associated email address. In this way everyone in your office will immediately receive the faxes that are sent to his own direct fax number.

Important: The internal number list can also be managed on the PC. See the next chapter about managing users.

There is also an **external** number list. The external number list is used to define fax recording numbers. This was only available in older models.

6.1.1 Add a new number to the internal number list

To access the number list on a desktop model:

- Press  **No.List** function key to open the number list menu.

To access the number list on a 19" model:

- Press the  **Settings** function key
- Press **LIST** softkey to open the number list menu.

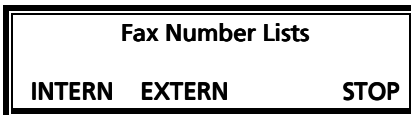

The Fax number lists.

- Press **INTERN**



The Fax number lists.

- Press **NEW** to add a new fax number to the list.



Enter the fax number

- Press **STORE** to add a new fax number to the list and continue with the email address.

Important: When entering fax numbers you can decide to include or exclude the area code. Do not use leading zeros. Keep it the same for all users (include or exclude area code). This will make it easier for the Fax Server to match the numbers with the numbers that are used on the telephone network.

E-mail: 
STORE CLEAR CANCEL

Enter the Email address.

Use the numerical keys to enter the Email address.

- Press **STORE** to save the number and Email address.
- Press **STOP** to leave the number list.

If any changes to the list have been made you will be prompted to save the changes. If you choose **NO** the list will remain unaltered.

6.1.2 Delete a number from the fax number list

- Select the Fax Number List menu.

Fax Number Lists		
INTERN	EXTERN	STOP

The Fax number lists.

- Press **INTERN** or **EXTERN**

faxes@company.com
123456
NEW DELETE STOP

The Fax number lists.

- Use the << and >> keys to scroll through the fax number list.
- Select the entry you want to delete.
- Press **DELETE** to remove the number
- Press **YES** to acknowledge.
- Press **STOP** to leave the number list.

If any changes to the list have been made you will be prompted to save the changes. If you choose **NO** the list will remain unaltered.

7 Managing Users

7.1 Introduction

User access to the Fax Server is for the users on the network who can have access in three ways:

- To receive faxes via email. A fax number must be created and a link must be made between the fax number and an email address.
- To send faxes. The users must be identified, to maintain the database and to prevent unwanted use.
- To access the database. Users must only be able to see those faxes that they are allowed to see.

The access is controlled in the Fax Server as a list of FTP accounts and as the internal number list.

The FTP user accounts are not only used to control the access, but also to maintain and personalize the Fax Servers archive.

- The Fax Server will keep track of who has sent or received a specific fax.
- The Fax Server will allow a user to view faxes that have been sent by specific users and to view faxes received on specific telephone extension numbers only.

The Fax Server Setup application for MS Windows is the tool for the network manager to create the internal number list via the LAN and to manage the FTP accounts.

There is no tool on the keyboard of the Fax Server to manage user access. The reason is that it would not be very practical.

The Fax Server Setup program on the PC does not keep any records by itself. Every time the application is started a connection to the Fax Server is required to retrieve the user information. This information can then be edited and uploaded to the Fax Server.

Important: It is possible to create user accounts without an FTP account. This is the same as the **INTERNAL NUMBER LIST**. When there is just an Internal Number list and when no user accounts are managed, you get a somewhat simplified installation of the Fax Server. Everyone would use

the same access code to send faxes or access the database. This might be perfectly acceptable for smaller organizations.

7.2 Installation of Fax Server Setup

Placing the CD-ROM in your computer gives you a choice of installation of Vidicode software. Choose to install the Fax Server Setup software. Follow the instructions on the screen. Part of the instructions is that the software will ask for a registration key that you will find packed with the software.

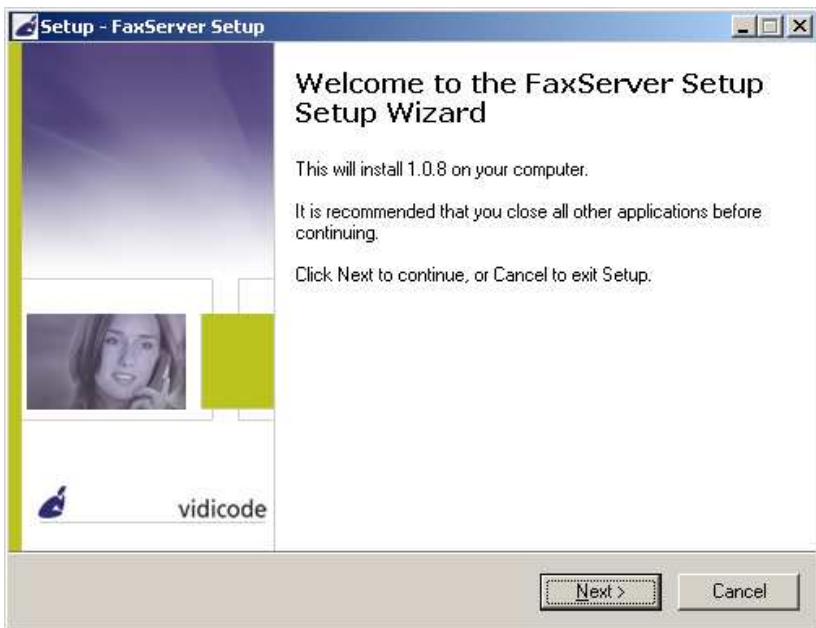

7.3 Software updates

It is always recommended to update your software to the latest revision. The Fax Server Setup application can be updated via internet.

Choose **Help** in the main menu and select "**Check for update**"

A new dialog opens where the current version is displayed. Click on the “**Check update**” button to check for updates. The program will check on the Vidicode website for updates of the program. If there are updates they will be displayed. Click “**do update**” to execute the update.

Note: The file that is downloaded is a zipped file that is unpacked by the application itself. Update files are approximately 1 Mb in size. Updates can not be executed while the program is performing other tasks. An open internet connection is required for this operation

7.4 Setting up a Fax Server

When the program is started the following dialog appears:

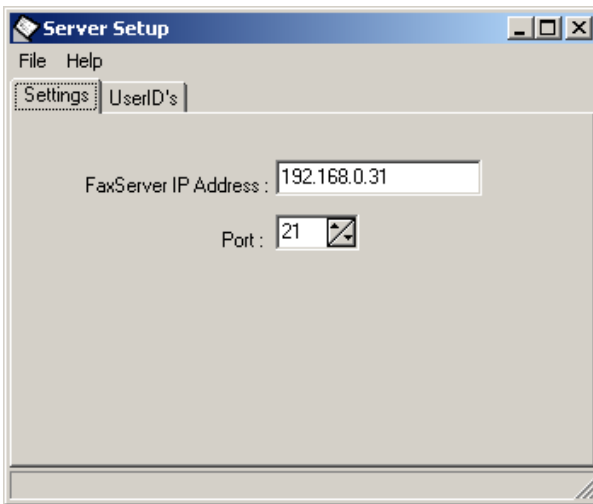

- Enter the Fax Server IP address.

The port setting on the Fax Server is default set to 21.

- Select the UserID's tab.

The Fax Server Setup will now come up with the following dialog for FTP username and password:

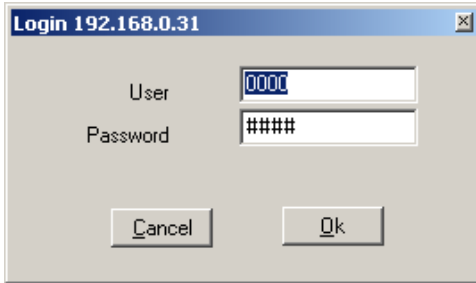

- Enter the administrator FTP username and password.

The Fax Server Setup will now make a connection to the Fax Server to retrieve user information.



Now select the User ID's tab after the connection has terminated. The user list as on the Fax Server is now displayed. If there is no user list present on the Fax Server the dialog will be blank.

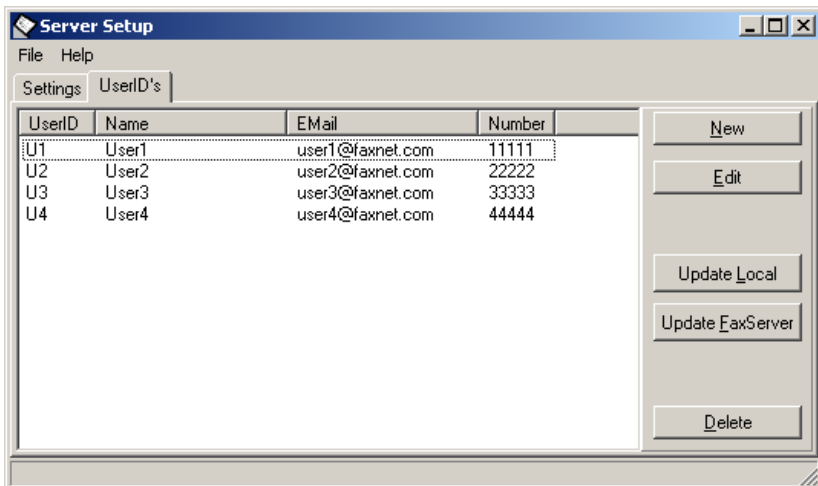

7.5 The user list

The user list displays the User ID, The username the email address and fax number.

The User ID consists of two characters; the user ID is used throughout the Fax Server applications to identify a user.

The username is the text that identifies the user for you.

The email address is the email address where faxes received for the user and confirmations of sending faxes are sent.

The Fax Number is the telephone number which is used as a fax number of the user.

Important: When entering fax numbers you can decide to include or exclude the area code. Do not use leading zero's. Keep it the same for all users (include or exclude area code). This will make it easier for the Fax Server to match the numbers with the numbers that are used on the telephone network.

7.6 Create a new user

Click **NEW** to create a new user.

The following dialog appears:

The image shows a 'New User' dialog box with the following fields and options:

- ID:** A small square icon.
- Name:** A text input field.
- E-mail address:** A text input field.
- FaxNumber:** A text input field.
- FTP Account:** A checkbox. If checked, it reveals:
 - Username:** A text input field.
 - Password:** A text input field.
- Access to all:** A checkbox. If checked, it reveals a list of existing users:
 - U1-user1
 - U2-User2
 - U3-User3
 - U4-User4
- Buttons:** 'Cancel' and 'Ok' buttons at the bottom.

Enter the user properties of the new user.

For every user there is an option to create an FTP account for the user. With the FTP account a user can setup a connection to the Fax Server with the Fax Server Access System software to view his or her faxes on the Fax Server. For every user access to existing user accounts can be set. Check the checkboxes of existing users in the list to enable access to the faxes of said users.

Click **OK** to finish.

7.7 Edit a user profile

A user profile is edited much the same way as creating a new user.

- Select a user in the list of users and click **"Edit"**

A new dialog appears with the selected user properties. Now you can edit the user properties.

- Click **OK** to save the changes.

At this point the user profile has changed in the user list as displayed on your screen. To save the list on the Fax Server the list needs to be transferred to the Fax Server.

Press "**Update Fax Server**" to transfer the user profiles to the Fax Server.

8 In service operation

Under normal circumstances the Fax Server does not need much attention. Operation is through the Fax Server Access System and Send Fax applications. Once the settings have been made the sending and receiving of faxes is automatic.

On the keyboard of the desktop model there are 5 function keys, which give access to functions of a Fax Server in operation. The 19" model has three of such function keys. The function keys are described in the following paragraphs.

To access the Archives on the desktop model and on the 19" model:



is the fax archive of sent and received faxes.

To access the queues on a desktop model:



To Email

function key to check the email queue and test email.



fax

To Fax

Fax queue function key to check the outgoing queue.

To access the queues on a 19" model:



To go to the Queue menu
Then choose with softkeys between the EMAIL,
FAX and PRINT queues

To view the free disk space on a desktop model:



Disc function key displays the free disk space.

To view the free disk space on a 19" model:



function key displays the free disk space.

8.1 Fax Archive

Press  **Archive** or  to open the Fax Archive.

There are two separate archives for Received and Sent faxes. Both archives are operated in the same manner. They are described in the following paragraphs; § 8.1.1 and § 8.1.2 Faxes in the archive can be sent again as fax (see § 8.3) or through email (see § 8.2).

8.1.1 Received faxes

Open the Fax Archive and press **RECEIVED** to open the received faxes archive.

- Press the **Received** key to enter the received faxes menu.



The Received faxes menu.

- Press **DISK** to open the respective item.

Received faxes archive can be searched on time, date and/or Fax ID.



Search the received faxes.

In the search the date time and Fax ID is always incorporated. You are first prompted to enter the date.

- Enter the date you want to search and press **SEARCH** to perform the search.

If you want to search on date only the Fax Server uses wildcards in the search strings for the time and Fax ID.

If you want to search according to date only you can enter wildcards for the date, e.g. ****:**:****.

It is possible to further refine your search according to Time.

- Press the **TIME** key
- Enter a time to search for. Use wildcards ***** (star key) to expand your search criteria, e.g. enter **13:**** to search for faxes received between **13:00** and **13:59** hours for the specified date or date range.
- Press **SEARCH** to search for the entered search string.

It is possible to further refine your search according to Fax ID.

- Enter a time or wildcards for in the Time search string and press **Fax ID**
- Enter a Fax ID to search for.
- Press **SEARCH** to search for the entered search string.

Use the double arrowed keys to scroll through the found faxes and select a fax. Use the single arrowed keys to scroll through the fax properties of the selected fax.

8.1.2 Sent faxes

Open the Fax Archive and press **SENT** to open the received faxes archive.

- Press the **Received** key to enter the received faxes menu.



The Sent faxes menu.

- Press **DISK** to open the respective item.

The Sent faxes archive can be searched on time, date and/or Fax ID.



Search the Sent faxes.

In the search the date time and Fax ID is always incorporated. You are first prompted to enter the date.

- Enter the date you want to search and press **SEARCH** to perform the search.

If you want to search on date only the Fax Server uses wildcards in the search strings for the time and Fax ID.

If you want to search according to date only you can enter wildcards for the date, e.g. ****:**:****.

It is possible to further refine your search according to Time.

- Press the **TIME** key
- Enter a time to search for. Use wildcards (star key) to expand your search criteria, e.g. enter **13:**** to search for faxes sent between **13:00** and **13:59** hours for the specified date or date range.
- Press **SEARCH** to search for the entered search string.

It is possible to further refine your search according to Fax ID.

- Enter a time or wildcards for in the Time search string and press **Fax ID**
- Enter a Fax ID to search for.
- Press **SEARCH** to search for the entered search string.

Use the double arrowed keys to scroll through the found faxes and select a fax. Use the single arrowed keys to scroll through the fax properties of the selected fax.

8.2 Email queue

The email queue is the queue of emails that have not (yet) been sent out. (This may be caused by an error in the mail server)

- Press **EMPTY** to empty the email queue, all emails in the queue are lost.
- Press **TEST** to place a test email in the queue. Normally a test email is sent in a matter of seconds.

8.2.1 Send an Email again

Faxes that are present in the archive can be sent again as Email. The fax can be sent to any Email address.

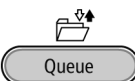
- Select a fax in the Received or Sent archive.
- Press the  function key (on a desktop model)
- Press the  function key (on a 19" model)



Email a fax from the archive.

- Enter the Email address or fax number.
- Press **STORE** to place the email in the queue.

The email queue is automatically processed every 5 minutes.

8.3 Fax Queue

The fax queue is the queue of faxes that have not(yet) been sent out. (This may be caused by an error from your service provider) Normally the Fax queue is empty.

- Press **EMPTY** to empty the fax queue, all faxes in the queue are lost.
- Press **BROWSE** to browse through the faxes in the queue. The browse menu is the same as the Archive menu as in in § 8.1.1 and § 8.1.2.

8.3.1 Send a fax again

Faxes that are present in the archive can be faxed again. The fax can be sent to any fax number.

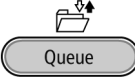
- Select a fax in the Received or Sent archive.
- Press the  function key (on a desktop model)
- Press the  Queue function key (on a 19" model)

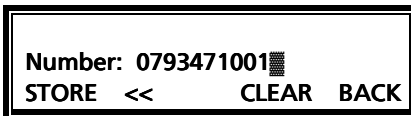

Fax a fax from the archive.

- Enter the fax number.
 - Press **STORE** to place the fax in the queue.
- The fax queue is automatically processed every 5 minutes.

8.4 Disk info

To show the free disk space of the Fax Server's internal storage on the bottom line of the display.

- Press the  **Disc** or HD/CD function key

Monday	24-04-02 10:26
Busy 0	Fax Rx/Tx 0/0
Free on disk: 9960 MB	

The free disk space

9 Acknowledgements

9.1 Guarantee

Your Fax Server has a 12-month factory guarantee. The guarantee is effective for normal use only. We would like to emphasize that the guarantee is not valid under exceptional environmental conditions, such as extreme temperatures or humidity levels, nor in the unlikely event of a lightning strike. The guarantee is not valid if the machine has not been handled properly, for example when it has been dropped, or bumped into. In order to qualify for guarantee, you should contact your supplier, and show the receipt. If your supplier cannot help you, you should contact the manufacturer. The manufacturer reserves the right to determine the final date of the guarantee period on the basis of the date of production. Costs of transport to and from the supplier or the manufacturer are for the buyer's account. Guarantee is for parts only and does not cover any costs resulting from the breakdown of the Fax Server.

The Fax Server has various extra features that have not been described in this manual. Additional information about this is given in a technical information bulletin. Subjects discussed in this technical documentation are further configuration options, remote configuring, and how to update the firmware in the Fax Server. The further configuration options concern all aspects of operation. In our experience most people are interested in configurations related to user's access.

9.2 Liability

Correct functioning of the Fax Server cannot be guaranteed under all conditions and thus we do not accept any liability for loss of information or other damages due to the use of the Fax Server.

Vidicode is not a source of official interpretation of laws of any country or state and shall not be construed as a source for making decisions.

10 INDEX

A

Acknowledgements, 73
Alfa-numerical functions, 9

C

Care and Maintenance, 10
clock, 38
Connect
 power supply, 19
 telephone lines, 20

D

day, 38
DHCP server, 42
Disk info, 71
Domain name, 48

E

E-mail address
 Fax Server, 45

F

Fax ID, 30
FTP password
 Fax Server, 41
FTP server port
 Fax Server, 41
FTP user
 Fax Server, 40
Function keys, 27
Function-keys, 8

G

Gateway, 44

guarantee, 73

I

Index, 74
Introduction, 15
IP address
 Fax Server, 43

L

Language
 Fax Server, 39
liability, 73

M

Menu keys, 27
Menu-key indicators, 28

N

Network
 Service timer, 54
Network settings
 Fax Server, 40

P

password protection
 Fax Server, 37
Power supply, 19

R

received faxes, 67, 68
Reply address, 46

S

sent again, 70, 71

Service timer, 54
SMTP server, 46
SMTP-server port, 48
subnet mask, 43

T

TelNet, 53
top line, 31

U

User interface, 27

V

volume, 36

W

wildcards, 68, 69