

Call Recorder APRESA & Call Recorder APRESA Compact

Installation Manual

V 4.3

(VC1988)



vidicode

Vidicode
Blauw-roodlaan 140

Phone
+31(0)79 3471000

Sales
+31(0)79 3471010

Email
info@vidicode.com





2718 SK Zoetermeer
The Netherlands

Fax
+31(0)79 3618092

Support
+31(0)79 3471005

Internet
www.vidicode.com

Care and Maintenance

	<p>Keep the APRESA dry. If it gets wet, wipe it dry immediately with a soft, clean cloth. Liquids might contain minerals that corrode the electronic circuits.</p>
	<p>Use and store the APRESA only in temperature conditions between 0 and 40 degrees Celsius. Temperature extremes can shorten the life of electronic devices and distort or melt plastic parts.</p>
	<p>Keep the APRESA away from excessive dust and dirt.</p>
	<p>Do not use aggressive chemicals, cleaning solvents or strong detergents to clean the APRESA.</p>
<p>LICENSES -</p>	<p>Store your APRESA licenses in a safe place as you may need these in the</p>

**THIS EQUIPMENT MUST BE
EARTHED
FOR SAFETY REASONS**

This manual was written to support and guide customers in the installation process of the hardware and software of the:

APRESA STANDARD VIDICODE 1U



APRESA STANDARD VIDICODE 4U

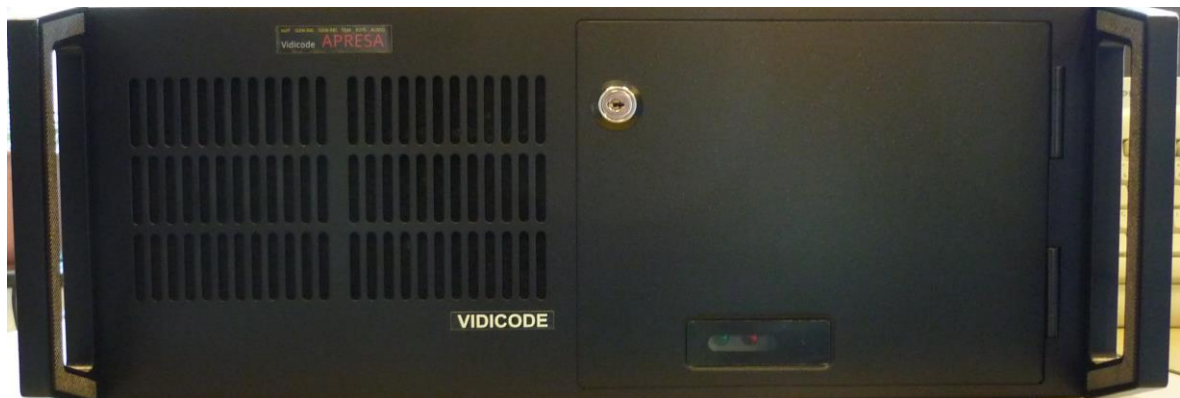

APRESA SUPER MICRO 1U SERVER



APRESA SUPER MICRO 4U SERVER



APRESA COMPACT IP5 – IP10 – D8 – A8 – M10



APRESA COMPACT VoIP



APRESA SOFTWARE ONLY



How to use this manual.

You may need an introduction to a “VIDICODE made” APRESA server, while others want to install the APRESA software-only on their alternative hardware.

Connecting the APRESA to the telecommunication infrastructure, the correct approach to signal tapping, will be an issue that most users will have to deal with.

Also, the expansion of existing APRESA systems may need some guidance. Expanding an APRESA system involves adding recording channels, increasing storage capacity or adding/ changing a RAID volume.

The purpose of this manual is to support you in an effective way. The document starts by presenting a road map that will guide you to the applicable sections for your situation. You will easily find the chapters that are relevant for your situation by using the flow chart.

Besides this installation manual there are some supporting documents related to Apresa:

- VC2019 CALL RECORDER APRESA ADMIN MANUAL, for administrators and users;
- VC1758 APRESA QUICK GUIDE, a startup helper to gain access to documentation;
- VC1886 APRESA BASE SOFTWARE QUICK GUIDE, a startup helper for ‘software only’ users;
- VC1926 ADDITIONAL INFORMATION FOR THE APRESA REDUNDANT POWER SUPPLY;
- VC1927 CALL RECORDER APRESA SERVER HARDWARE REQUIREMENTS;
- VC2186 HOW TO UPDATE THE BASE SOFTWARE;
- VC2238 APRESA SUPPORT AND UPGRADES.

Refer to the VIDICODE price list for available APRESA articles, article codes and pricing.

THIS MANUAL IS FREQUENTLY UPDATED WITHOUT ANY NOTIFICATION



**SO, YOU ARE STRONGLY ADVISED TO DOWNLOAD THE NEWEST RELEASE OF THIS MANUAL
FROM THE WEBSITE BELOW
THANK YOU**

www.vidicode.com

CONTENTS

- 1. DOCUMENT USE..... 11**
 - 1.1. SITUATIONS 11**
 - 1.1.1. *The “made by VIDICODE” APRESA Server / APRESA Compact. 11*
 - 1.1.2. *Apresa ‘Software only’ 11*
 - 1.1.3. *Expanding an existing APRESA..... 11*
 - 1.2. PACKAGE CONTENTS, MATERIALS AND TOOLING 12**
 - 1.2.1. *Package contents 12*
 - 1.2.2. *Advised Materials 12*
 - 1.2.3. *Advised tooling 13*
- 2. INTRODUCTION TO THE APRESA SERVER..... 13**
 - 2.1. APRESA STANDARD VIDICODE 4U SERVER..... 16**
 - 2.1.1. *Specifications..... 17*
 - 2.1.2. *Enclosure..... 17*
 - 2.1.3. *Motherboard / CPU / RAM / PSU..... 17*
 - 2.1.4. *Hard drive (various configurations possible) 17*
 - 2.1.5. *Supported PCIe interface card 18*
 - 2.1.6. *Environmental specification 18*
 - 2.1.7. *Approvals..... 18*
 - 2.2. APRESA STANDARD VIDICODE 1U SERVER..... 19**
 - 2.2.1. *Specifications..... 19*
 - 2.2.2. *Enclosure..... 19*
 - 2.2.3. *Motherboard / CPU / RAM / PSU..... 19*
 - 2.2.4. *Hard drive (various configurations possible) 20*
 - 2.2.5. *Supported PCI interface card 20*
 - 2.2.6. *Supported PCIe interface card 20*
 - 2.2.7. *Environmental specification 20*
 - 2.2.8. *Approvals..... 20*
 - 2.3. APRESA SUPER MICRO 1U SERVER..... 21**
 - 2.3.1. *Specifications..... 21*
 - 2.3.2. *Enclosure..... 21*
 - 2.3.3. *Motherboard / CPU / RAM / PSU..... 21*
 - 2.3.4. *Hard drive (various configurations possible) 22*
 - 2.3.5. *Supported PCIe interface card 22*
 - 2.3.6. *Environmental specification 22*
 - 2.3.7. *Approvals..... 22*
 - 2.4. APRESA SUPER MICRO 4U SERVER..... 23**
 - 2.4.1. *Specifications..... 23*
 - 2.4.2. *Enclosure..... 23*
 - 2.4.3. *Motherboard / CPU / RAM / PSU..... 24*
 - 2.4.4. *Hard drive (various configurations possible) 24*
 - 2.4.5. *Supported PCIe interface card 24*
 - 2.4.6. *Environmental specification 25*
 - 2.4.7. *Approvals..... 25*
 - 2.5. THE APRESA-COMPACT..... 26**
 - 2.5.1. *Specifications..... 27*
 - 2.5.2. *Enclosure..... 27*
 - 2.5.3. *Motherboard / CPU / RAM / PSU..... 28*
 - 2.5.4. *Hard drive 28*
 - 2.5.5. *Supported PCIe interface cards 28*
 - 2.5.6. *Environmental specification 28*
 - 2.5.7. *Approvals..... 28*
 - 2.6. THE APRESA-COMPACT (VOIP-ONLY)..... 29**

2.6.1.	Specifications.....	29
2.6.2.	Enclosure.....	29
2.6.3.	Motherboard / CPU / RAM / PSU.....	29
2.6.4.	Hard drive	29
2.6.5.	Environmental specification	30
2.6.6.	Approvals.....	30
2.7.	HARDWARE REQUIREMENTS	32
2.8.	INTERFACE CARD INSTALLATION PROCEDURE.....	32
2.9.	APRESA BASE SOFTWARE INSTALLATION PROCEDURE BY USING A USB STICK.....	34
2.9.1.	BIOS setup.....	34
2.9.2.	Preparations.....	35
2.9.3.	Prepare a bootable USB-Stick for Apresa Base Software Installation.....	37
2.9.4.	Apresa Base Software Installation using the USB-stick	39
2.9.5.	Access the Apresa for the first time	41
2.9.6.	BASE SOFTWARE Licensing	45
2.9.7.	Channel Licensing.....	50
2.9.8.	SYNWAY driver installation.....	51
2.9.9.	S&U licensing.....	53
2.9.10.	Base Software Update.....	53
2.9.11.	Install the IPMI driver	53
2.9.12.	Install add-storcli	54
2.9.13.	Help for installation of APRESA on Virtual Machines	54
2.9.14.	Help for installation of Apresa on an existing Debian machine (Cloud).....	54
2.9.15.	General APRESA configuration	55
3.	MOUNTING.....	56
3.1.	LOCATION CONSIDERATIONS.....	56
3.2.	MOUNTING APRESA INTO A 19-INCH CABINET	57
3.3.	APPLY POWER TO THE APRESA.	57
4.	TELECOM WIRING	58
4.1.	INTRODUCTION	58
4.2.	CONNECTOR LOCATIONS.....	60
4.3.	GENERAL REMARKS ABOUT WIRING	60
4.4.	WIRING AUDIO TAPS.....	61
4.4.1.	Balanced signals.....	61
4.4.2.	Un-balanced signals.....	62
4.4.3.	Wiring using the RJ11 Patch Box	63
4.4.4.	Direct wiring (NOT using a Patch Box).....	64
4.5.	WIRING ANALOG TELEPHONY (POTS) TAPS	65
4.6.	WIRING TDM TELEPHONY TAPS	67
4.6.1.	2-Wire Vs. 4-Wire	67
4.6.2.	Wiring schemes.....	67
4.7.	WIRING ISDN2 TELEPHONY TAPS (BASIC RATE ISDN)	70
4.8.	WIRING ISDN E1/T1 TELEPHONY TAPS.....	71
4.9.	CONFIGURATION OF VOIP TELEPHONY RECORDING	74
4.9.1.	Trunk Side Recording.....	74
4.9.2.	Station Side Recording.....	75
4.9.3.	VoIP topology 1	78
4.9.4.	VoIP topology 2	79
4.9.5.	VoIP topology 3	80
4.9.6.	VoIP topology 4	81
4.9.7.	VoIP topology 5	82
4.9.8.	VoIP topology 6	83
4.9.9.	VoIP topology 7.....	84
4.10.	CONFIGURATION OF TETRA COMMUNICATION RECORDING	84
4.11.	PATCH PANELS	85
4.11.1.	RJ11 Patch panel.....	85
4.11.2.	The Tapping Patch box.....	87
5.	EXPANDING APRESA.....	89

5.1.	HOW TO ADD RECORDING CHANNELS	89
5.1.1.	<i>Channel license upgrade</i>	89
5.1.2.	<i>Installation of interface cards</i>	90
5.1.3.	<i>Installation of interface modules</i>	90
5.1.4.	<i>Increasing the storage capacity</i>	92
5.1.5.	<i>Building or changing a software RAID volume</i>	92
6.	BACKUP AND RESTORE BACKUP.....	93
7.	MAINTENANCE.....	95
7.1.	HARDWARE.....	95
7.2.	SOFTWARE.....	95
8.	REDUNDANT POWER SUPPLY.....	96
9.	STORAGE OPTIONS	98
9.1.	CONFIGURATION	98
9.2.	GENERAL INFORMATION	99
9.3.	HOW TO REPLACE A FAILING HARD DRIVE IN A HARDWARE-RAID VOLUME.....	100
9.4.	REPLACING A FAILED HARD DISK IN A RAID ARRAY	100
10.	ADVISED HARDWARE RAID CONTROLLER CARD	102
11.	INTERFACE CARD SPECIFICATIONS	103
11.1.	ATP-24A/PCI+/2.0 / ATP-24A/PCIe+/2.0 / ATP-24A/PCIe+/3.0.....	104
11.2.	DST-24B/PCI+/2.0 / DST-24B/PCIe+/2.0	105
11.3.	DTP-X0C/PCI+ / DTP-X0C/PCIe+	106
11.4.	GNU GENERAL PUBLIC LICENSE.....	107
12.	TERMINOLOGY EXPLAINED.....	109
13.	COPYRIGHT AND TRADEMARKS.....	112
14.	FCC STATEMENT	112
15.	ROHS 2 STATEMENT	112

ROAD MAP

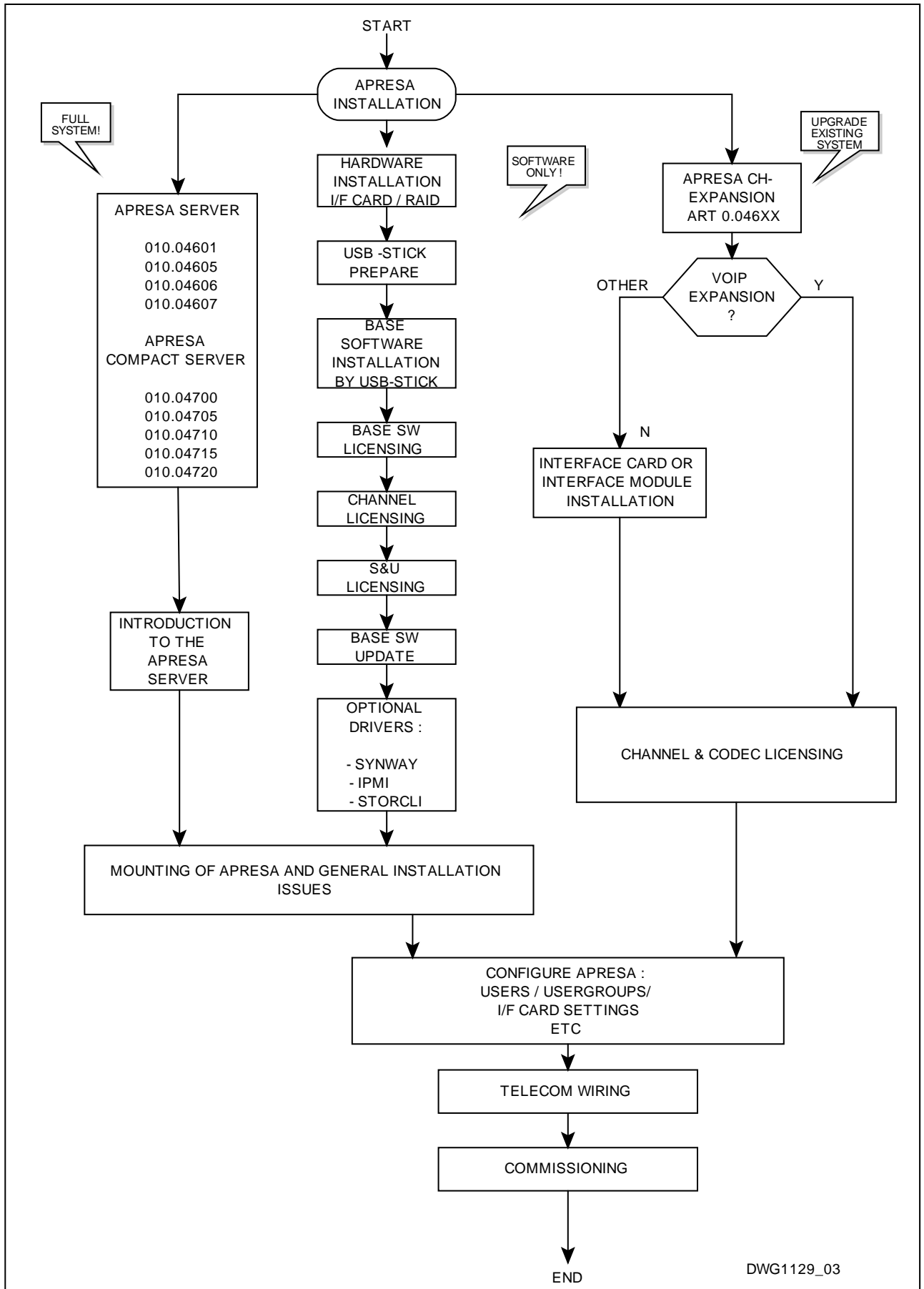

1. Document use

Generally, we distinguish 3 different situations of use of this document. You are advised to follow the relevant path for your applicable situation as indicated by the roadmap. The numbers in the roadmap link to the chapters of interest, avoiding unnecessary reading of irrelevant chapters.

At the end of this chapter you find a list of required materials and tooling to do the job right.

1.1. *Situations*

1.1.1. The “made by VIDICODE” APRESA Server / APRESA Compact.

The APRESA is available on the market as a turn-key product, either a 19” rack or a desktop version. You will find the APRESA base software already installed and running on the product. The channel licenses are activated and interface cards will be installed according to your purchase order by VIDICODE. You are advised to read the introduction and then go directly to the mounting, software configuration, telecom wiring, and the commissioning sections.

1.1.2. Apresa ‘Software only’

You prefer to use your own choice of hardware for a variety of reasons. In other words, you have the liberty to select your preferred server manufacturer like HP, Dell, etc. or use a virtual machine.

To support customers in the selection of the server hardware we offer a guiding list in a separate quick guide, named “CALL RECORDER APRESA, Server Hardware requirements (VC1927).

To install the APRESA software image and do the channel licensing one is advised to follow the directions as described in the chapter “Software installation”. For the installation of interface cards in your hardware you must follow the directions of the manufacturer or vendor of that machine.

Finally process the software configuration, telecom wiring and the commissioning section.

1.1.3. Expanding an existing APRESA

If you want to expand an existing APRESA system with additional channels or interface card(s) you can go to the ‘Expanding Apresa’ chapter.

Existing APRESA systems need channel upgrade when customer business expands after time and more and more phones needs to be recorded. Adding and configuration of new channels in software is easy, the main effort here is hardware installation.

Note that the APRESA Compact supports standard (NORAID) hard drive only, and this model is limited to max. 10 channel VoIP or 8 channel TDM or 8 channel Analog (POTS/audio).

1.2. Package contents, materials and Tooling

1.2.1. Package contents

Open the package carefully, and verify that the box content is correct

This product has a very high level of flexibility and inherently there is no standard package content. To help you in checking the delivery use the following table:

Description BOX content	010.04602/3/4 Apresa Software only	010.04607 Apresa standard Vidicode 1U	010.04601 Apresa standard Vidicode 4U	010.04605 Apresa Super Micro 1U	010.04606 Apresa Super Micro 4U	010.047XX Apresa Compact D8-A8-M10	010.047XX Apresa Compact IP5-IP10
APRESA CALL RECORDER	-	1	1	1	1	1	1
MAINS POWER CORD	-	1	1	2	2	1	1
MAINS POWER ADAPTOR	-	-	-	-	-	-	1
KEY (FOR DOOR LOCK)	-	-	1	-	-	-	-
QUICK GUIDE APRESA INSTALLATION	1						
APRESA BASE SOFTWARE LICENSE	1						
APRESA CLIENT SOFTWARE LICENSE	1						
S&U LICENSE	1						
GUARANTEE / REGISTRATION FORM	1						
CHANNEL LICENSE	QTTY delivered according to customer order						
PATCHBOX RJ11/RJ21	1 Pcs / ATP/DST interface card						
RJ21/RJ21 CABLE, LENGTH=1M	1 Pcs / ATP/DST interface card						
RJ45 'T'-SPLITTER (TRIPLEXER)	1 Pcs / Trunk DTP interface card						
ISDN cable L=2m	1 Pcs / Trunk DTP interface card						

If an item is missing or damaged, please contact your local reseller for service.

1.2.2. Advised Materials

We advise you to check the following list of materials before you start installing the system.

- * 19" Rack screws and cage nuts
- * Modular plugs RJ12, RJ45
- * RJ12 T-Splitter(s)
- * Tapping Patch box
- * Coaxial T-Splitter(s)
- * Modular wire 4P/6P/8P
- * RJ45 T-splitter(s)
- * RJ21 cable(s) 3, 5 or 10m length
- * RJ45 to BNC adapter
- * Etcetera, etc.....

1.2.3. Advised tooling

We advise you to check the following list of tooling of before you start installing the system:

- Standard installers tooling kit;
- RJ modular connector crimp tool

2. Introduction to the APRESA server

The APRESA server is on the market in several forms:

1. Apresa Standard Vidicode 4U server.

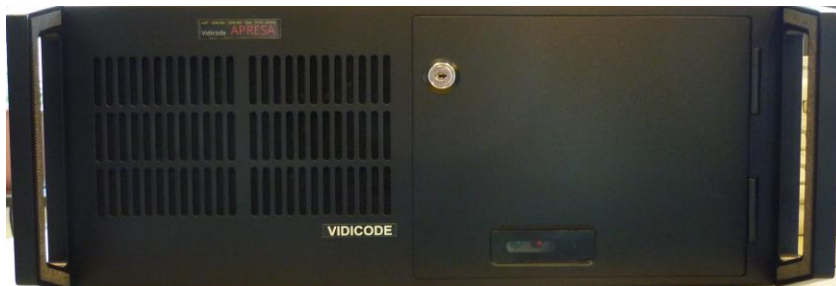

This version is based on industrial-grade PC server components. The housing is fully compatible with 19-inch server cabinets and will take 4U cabinet space. All basic controls and indicators are safely placed behind a lockable door. Please note that the door-lock-keys are universal (e.g. identical between different APRESA units). The Apresa Base Software is pre-installed by VIDICODE. Note that there is no redundant PSU option available for this model.

2. Apresa Standard Vidicode 1U server.



This version is based on industrial-grade PC server components and fully compatible with 19-inch server cabinets by taking only 1U cabinet space. No redundant PSU option available.

3. Apresa Super Micro 1U server.



This model is equipped with a redundant PSU and sliding rails as standard.

4. Apresa Super Micro 4U server.



This model is equipped with a redundant PSU, RAID option

5. The DESKTOP housing, the APRESA-Compact



This version is based on standard quality PC components build in a HTPC housing. It is intended to be a small scale and lowest-cost recording solution for Analog, ISDN2 or TDM.

6. The DESKTOP housing, the APRESA-Compact VoIP



This version is based on standard quality PC components. It is intended to be a small scale and lowest-cost recording solution for VoIP.

All APRESA-options ordered are pre-installed by VIDICODE:

You will find APRESA Base software license, CHANNEL licenses, etc. **These are just for your safekeeping only.** You need these items only when you want to re-install the software.

Interface card(s) that are ordered for these machines will be pre-installed.

The following sub-sections describe the various types of housing in functional and specifications detail.

2.1. *Aprisa standard Vidicode 4U server*



Back side, X11-SCL-F motherboard.

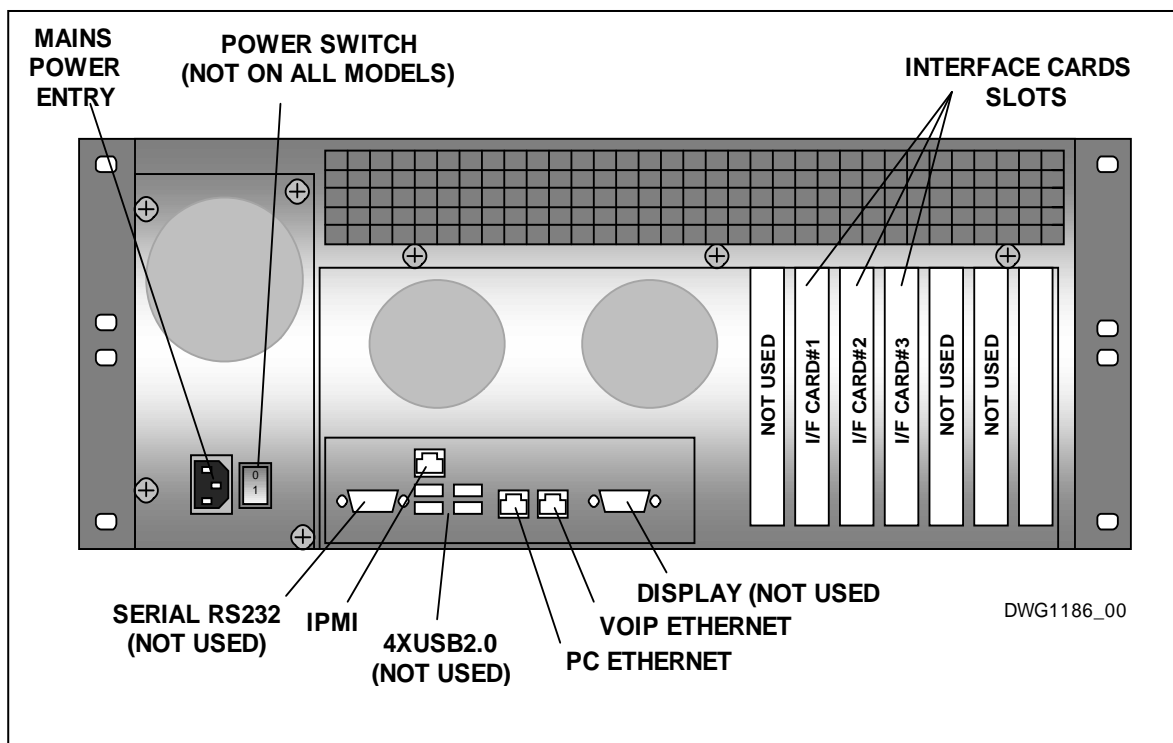

2.1.1. Specifications

2.1.2. Enclosure

TYPE	: InWin 19INCH/ 4U
COLOR	: Black door, Black sheet metal (Textured)
WEIGHT	: 15 Kg (approximately, varies with different models)
DIMENSIONS	
-Height	: 177 mm (4U)
-Width	: 482 mm (19" RACK mounting brackets standard) 440 mm (desktop, 19" brackets removed)
-Depth	: 540 mm (Including handle bars, exclusive cables)
SLIDING RAIL	: NOT available
# 3.5" DRIVES	: 2 Pcs INTERNAL
# 5.25" DRIVES	: 3 Pcs EXTERNAL
# USB	: 2 pcs placed on front / 6pcs at the back (Not used)
COOLING	: Front FAN 120mm, chassis FAN 1600 RPM, CPU FAN
ACCESS CTRL	: Controls / indicators are placed behind a lockable door
CONTROLS	: -RESET Button -ON/OFF Switch
INDICATORS	: -Power -Hard drive ACTIVITY

2.1.3. Motherboard / CPU / RAM / PSU

MOTHERBOARD	: SUPER MICRO X11SCL-F (Socket 1151) (for all specifications: www.supermicro.com)
CPU	: INTEL PENTIUM G5400 2 x 3.7GHz 3MB cache (for all specifications: www.intel.com)
RAM	: DDR4: 4 GBYTE @ 1300MHZ, ECC, Standard DDR4: 32GBYTE @ 1600MHZ, ECC, Max.
PSU	: 300W Standard (not redundant) 500W Optional (not redundant) (for all specifications: www.supermicro.com)
PCI-e	: 3 slots

2.1.4. Hard drive (various configurations possible)

INTERFACE	: SATA 6GBIT/SEC
SIZE	: 3.5 INCH
RPM	: 7200
CACHE	: 64MByte
QUALITY GRADE	: 24/7
CAPACITY	: 1T BYTE (standard configuration) Optional 1or 2 TBYTE
RAID VOLUMES	: Optional, Software RAID1

BACKUP DRIVE : Supported, 1,2 or 3 TB

2.1.5. Supported PCIe interface card

All cards below are designed for the PCIe X1 card slot.

note: These interface cards will work also in PCIe X4/X8/X16/X32 slots.

ANALOG	: SYNWAY TYPE ATP-24A/PCIe+/2.0 : 8CH / 16CH or 24CH
	SYNWAY TYPE ATP-24A/PCIe+/3.0 : 8CH / 16CH or 24CH
TDM	: SYNWAY TYPE DST-24B/PCIe+/2.0 : 8CH / 16CH or 24CH
ISDN E1/T1	: SYNWAY TYPE DTP-30C/PCIe+/2.0 : 30CH / 1TRUNK
ISDN60 (E1)	: SYNWAY TYPE DTP-60C/PCIe+/2.0 : 60CH / 2TRUNK
ISDN120(E1)	: SYNWAY TYPE DTP-120C/PCIe+/2.0 : 120CH / 4TRUNK

2.1.6. Environmental specification

TEMPERATURE : +10 +35 °C (Operating) or - 10 + 65 °C (Storage)

HUMIDITY : 8%-90% No condensing, operating and storage.

2.1.7. Approvals

EMC APPROVAL : EN55022 / EN55024 / FCC15

SAFETY : EN60950

2.2. Apresa standard Vidicode 1U server

Front side



Back side



2.2.1. Specifications

2.2.2. Enclosure

TYPE	: CSE 510-203B (Super Micro)
COLOR	: Black sheet metal (Textured)
WEIGHT	: 4 Kg (approximately, varies with different models)
DIMENSIONS	
-Height	: 44.45 mm (1U)
-Width	: 482 mm (19" RACK mounting brackets standard) 440 mm (desktop, 19" brackets removed)
-Depth	: 287 mm (Including handle bars, exclusive cables)
SLIDING RAIL	: Not available/ Not Supported
# 2.5" DRIVES	: 1 pcs INTERNAL
# 5.25" DRIVES	: not Supported
# USB	: 4 pcs at the back (Not used)
COOLING	: 2 pcs 40mm chassis FAN 8500 RPM , CPU passive cooling
CONTROLS	: -RESET Button -ON/OFF Button
INDICATORS	: -Power -Hard drive ACTIVITY

2.2.3. Motherboard / CPU / RAM / PSU

MOTHERBOARD	: SUPER MICRO X11SCL-F (Socket 1151) (for all specifications: www.supermicro.com)
CPU	: INTEL PENTIUM G5400 2 x 3.7 GHz 3MB cache

	(for all specifications: www.intel.com)
RAM	: DDR4: 8 GBYTE @ 1300 MHZ, ECC, Standard DDR4: 32GBYTE @ 1600MHZ, ECC, Max.
PSU	: 200W no redundancy
PCI-e	: 3 slots (only 1 slot available externally by use of a riser card)

2.2.4. Hard drive (various configurations possible)

INTERFACE	: SATA 6GBIT/SEC
SIZE	: 2.5 INCH
RPM	: 7200
CACHE	: 32MByte
QUALITY GRADE	: 24/7
CAPACITY	: 1T BYTE (standard configuration) Optional 2 TBYTE
RAID VOLUMES	: not Supported
BACKUP DRIVE	: not Supported

2.2.5. Supported PCI interface card

This model has NO support for legacy PCI interface cards.

2.2.6. Supported PCIe interface card

All cards below are designed for the PCIe X1 card slot.

note: These interface cards will work also in PCIe X4/X8/X16/X32 slots.

ANALOG	: SYNWAY TYPE ATP-24A/PCIe+/2.0 : 8CH / 16CH or 24CH SYNWAY TYPE ATP-24A/PCIe+/3.0 : 8CH / 16CH or 24CH
TDM	: SYNWAY TYPE DST-24B/PCIe+/2.0 : 8CH / 16CH or 24CH
ISDN E1/T1	: SYNWAY TYPE DTP-30C/PCIe+/2.0 : 30CH / 1TRUNK
ISDN60 (E1)	: SYNWAY TYPE DTP-60C/PCIe+/2.0 : 60CH / 2TRUNK
ISDN120(E1)	: SYNWAY TYPE DTP-120C/PCIe+/2.0 : 120CH / 4TRUNK

2.2.7. Environmental specification

TEMPERATURE	: +10 +35 °C (Operating) or - 10 + 65 °C (Storage)
HUMIDITY	: 8%-90% No condensing, operating and storage.

2.2.8. Approvals

EMC APPROVAL	: EN55022 / EN55024 / FCC15
SAFETY	: EN60950

2.3. Apresa Super Micro 1U server

Front side:



Back side:



2.3.1. Specifications

2.3.2. Enclosure

TYPE	: Super Micro CSE-813MTQ-R400CB
COLOR	: Black front, sheet metal.
WEIGHT	: 9 Kg (approximately, varies with different models)
DIMENSIONS	
-Height	: 44,45 mm (1U)
-Width	: 482 mm (19" RACK mounting brackets standard) 440 mm (desktop, 19" brackets removed)
-Depth	: 570 mm (Including handle bars, exclusive cables)
SLIDING RAIL	: Standard supplied, must be used with cabinet mounting due to only 1U Height
# 3.5" DRIVES	: 4 pcs EXTERNAL BAYS
# 5.25" DRIVES	: Not available
# USB	: 2 pcs placed on front side, 4 pcs placed on back side
COOLING	: 4 pcs chassis FAN 8500 RPM , CPU passive cooling
ACCESS CTRL	: On front side
CONTROLS	: -RESET Button -ON/OFF Switch
INDICATORS	: -Power -Hard drive ACTIVITY

2.3.3. Motherboard / CPU / RAM / PSU

MOTHERBOARD	: SUPER MICRO X11SCL/F (Socket 1151) (for all specifications: www.supermicro.com)
CPU	: INTEL PENTIUM G5400 3.7 GHz 3MB cache (for all specifications: www.intel.com)
RAM	: DDR4: 4 GBYTE @ 1300 MHZ, ECC, Standard

DDR4: 32GBYTE @ 1600MHZ, ECC, Max.
 PSU : 400+400W redundant
 PCI : Not Supported
 PCI-e : 3 slots (only 1 slot available externally by use of a riser card)

2.3.4. Hard drive (various configurations possible)

INTERFACE : SATA 6GBIT/SEC
 SIZE : 3.5 INCH
 RPM : 7200
 CACHE : 64MByte
 QUALITY GRADE : 24/7
 CAPACITY : 1 T BYTE (standard configuration)
 Optional 1or 2 TBYTE
 RAID VOLUMES : Optional: Software RAID1, Hardware RAID1/10
 BACKUP DRIVE : Supported, 1,2 or 3 TB

2.3.5. Supported PCIe interface card

All cards below are designed for the PCIe X1 card slot.

Note: These interface cards will work also in PCIe X4/X8/X16/X32 slots.

ANALOG : SYNWAY TYPE ATP-24A/PCIe+/2.0 : 8CH / 16CH or 24CH
 SYNWAY TYPE ATP-24A/PCIe+/3.0 : 8CH / 16CH or 24CH
 TDM : SYNWAY TYPE DST-24B/PCIe+/2.0 : 8CH / 16CH or 24CH
 ISDN E1/T1 : SYNWAY TYPE DTP-30C/PCIe+/2.0 : 30CH / 1TRUNK
 ISDN60 (E1) : SYNWAY TYPE DTP-60C/PCIe+/2.0 : 60CH / 2TRUNK
 ISDN120(E1) : SYNWAY TYPE DTP-120C/PCIe+/2.0 : 120CH / 4TRUNK

2.3.6. Environmental specification

TEMPERATURE : +10 +35 °C (Operating) or - 10 + 65 °C (Storage)
 HUMIDITY : 8%-90% No condensing, operating and storage.

2.3.7. Approvals

EMC APPROVAL : EN55022 / EN55024 / FCC15
 SAFETY : EN60950

2.4. Apresa Super Micro 4U server

Front side:

(Current models are shipped without the DVD)

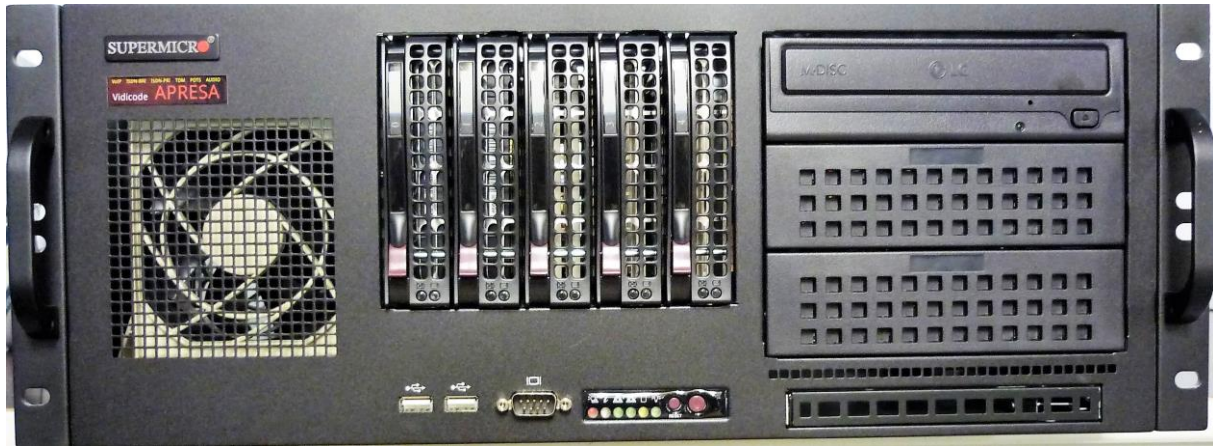

Back side:

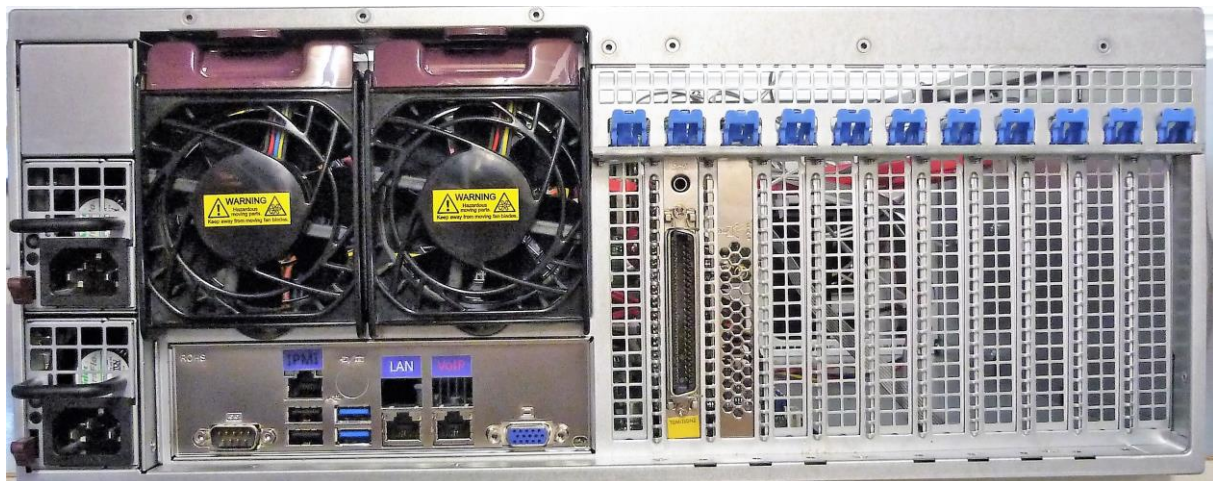

2.4.1. Specifications

2.4.2. Enclosure

TYPE	: Super Micro CSE-842XTQ-R606B
COLOR	: Black front, sheet metal.
WEIGHT	: 18 Kg (approximately, varies with different models)
DIMENSIONS	
-Height	: 117 mm (4U)
-Width	: 482 mm (19" RACK mounting brackets standard) 440 mm (desktop, 19" brackets removed)
-Depth	: 580 mm (Including handle bars, exclusive cables)
SLIDING RAIL	: Optional
# 3.5" DRIVES	: 5 pcs EXTERNAL BAY

# 5.25" DRIVES	: 3 pcs EXTERNAL BAY
# USB	: 2 pcs placed on front side, 4 pcs on the back side
COOLING	: 2 pcs chassis FAN 2400 RPM 1 pcs chassis FAN 120mm 1200RPM CPU FAN (BOXFAN by INTEL)
ACCESS CTRL	: On front side
CONTROLS	: -RESET Button -ON/OFF Switch
INDICATORS	: -Power -Hard drive ACTIVITY

2.4.3. Motherboard / CPU / RAM / PSU

MOTHERBOARD	: SUPER MICRO X11SCL-F (Socket 1151) (for all specifications: www.supermicro.com)
CPU	: INTEL PENTIUM G5400 2 x 3.7GHz 3MB cache (for all specifications: www.intel.com)
RAM	: DDR4, 8 GBYTE @ 1300 MHZ, ECC, Standard DDR4, 32GBYTE @ 1600MHZ ECC, Max.
PSU	: 800+800W redundant
PCI-e	: 3 slots (all 3 available externally)

2.4.4. Hard drive (various configurations possible)

INTERFACE	: SATA 6GBIT/SEC
SIZE	: 3.5 INCH
RPM	: 7200
CACHE	: 64MByte
QUALITY GRADE	: 24/7
CAPACITY	: 1 T BYTE (standard configuration) Optional 2 TBYTE
RAID VOLUMES	: Optional, Software RAID1, Hardware RAID1/10
BACKUP DRIVE	: Supported, 1,2 or 3 TB

2.4.5. Supported PCIe interface card

All cards below are designed for the PCIe X1 card slot.

note: These interface cards will work also in PCIe X4/X8/X16/X32 slots.

ANALOG	: SYNWAY TYPE ATP-24A/PCIe+/2.0 : 8CH / 16CH or 24CH SYNWAY TYPE ATP-24A/PCIe+/3.0 : 8CH / 16CH or 24CH
TDM	: SYNWAY TYPE DST-24B/PCIe+/2.0 : 8CH / 16CH or 24CH
ISDN E1/T1	: SYNWAY TYPE DTP-30C/PCIe+/2.0 : 30CH / 1TRUNK
ISDN60 (E1)	: SYNWAY TYPE DTP-60C/PCIe+/2.0 : 60CH / 2TRUNK
ISDN120(E1)	: SYNWAY TYPE DTP-120C/PCIe+/2.0 : 120CH / 4TRUNK

2.4.6. Environmental specification

TEMPERATURE : +10 +35 °C (Operating) or - 10 + 65 °C (Storage)
HUMIDITY : 8%-90% No condensing, operating and storage.

2.4.7. Approvals

EMC APPROVAL : EN55022 / EN55024 / FCC15
SAFETY : EN60950

2.5. The APRESA-Compact



Front side, door closed

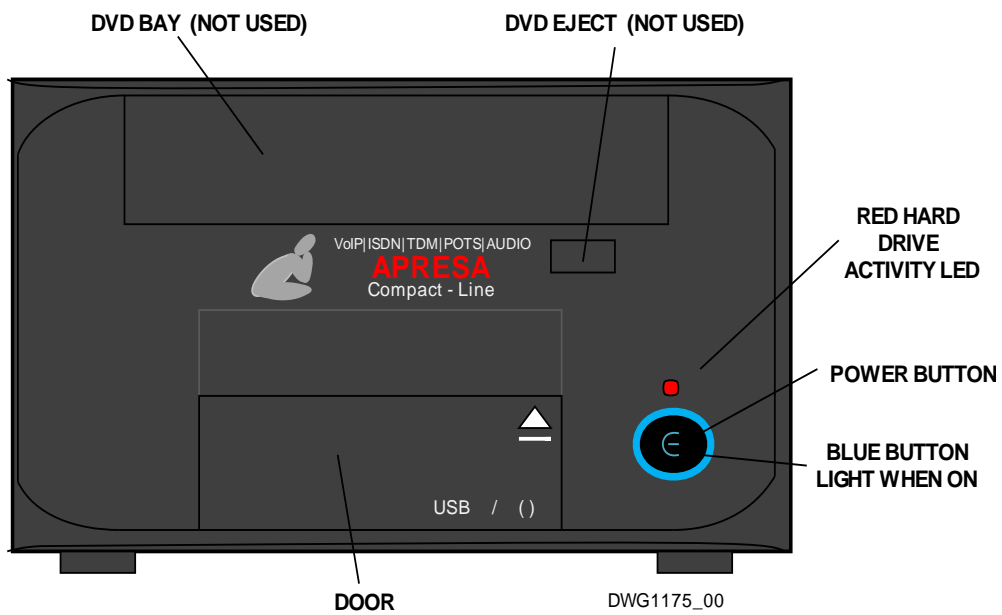

Front side, door opened

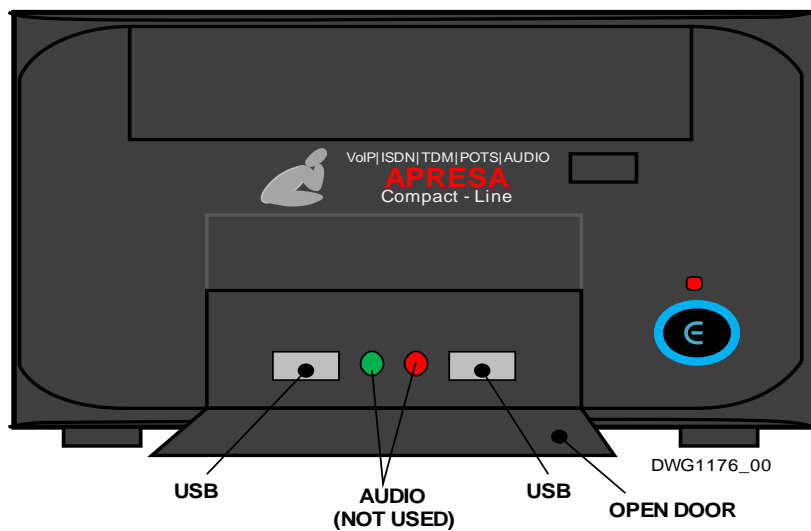

Back side (backplane depends upon the motherboard used)

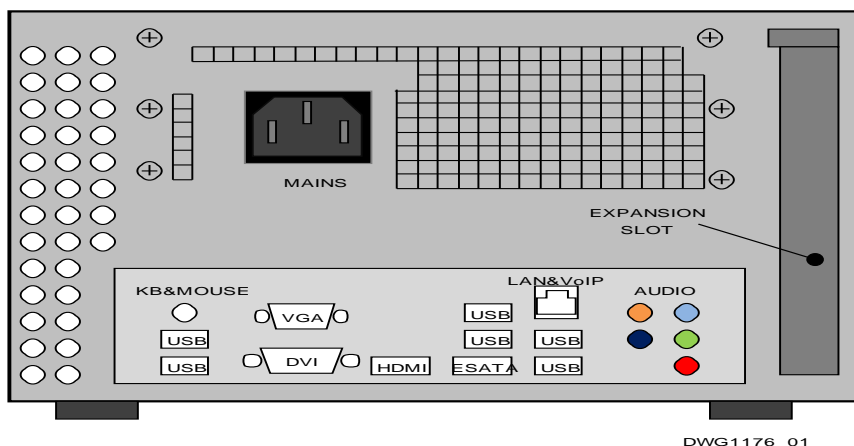

Note: The Keyboard & Mouse Mini-din connector is **not** supported under APRESA.

-> Use a **USB** Keyboard and **USB** Mouse ONLY

Remarks about the use of the expansion slot:

- The “APRESA-Compact IP5” and the “APRESA-Compact IP10” have a network card installed (in the PCI-e expansion slot) marked ‘LAN’ to interface the normal LAN. The motherboard LAN is marker ‘VoIP’ and should connect to the VoIP-LAN.
- The APRESA-Compact D8 and the APRESA-Compact A8 have a line interface card installed (ATP or DST) capable to capture 8 recording channels. The motherboard LAN is marked ‘LAN’ and should connect normal LAN.

2.5.1. Specifications

2.5.2. Enclosure

TYPE	: SPIRE SPM210B-300W-PFC, PSU included (or equivalent)
COLOR	: Piano BLACK
WEIGHT	: 3.5 Kg (approximately, varies with different models)
DIMENSIONS	
-Height	: 135 mm
-Width	: 220 mm
-Depth	: 345 mm (excluding cables)
# 3.5” DRIVES	: 1 INTERNAL
# 5.25” DRIVES	: 1 EXTERNAL, not used
# USB	: 2 pcs placed on front side, 6 pcs on the back side
COOLING	: PSU-FAN, CPU passive cooling.
CONTROLS	: -ON/OFF Switch

INDICATORS : -Power (Blue LED)
-Hard drive ACTIVITY (red LED)

2.5.3. Motherboard / CPU / RAM / PSU

MOTHERBOARD : ASROCK Q1900B-ITX (or equivalent)
(for all specifications: www.asrock.com)
CPU : INTEL J1900, 64bit, Quad core 4 x 2.0GHz, 2MB cache
(for all specifications: www.intel.com)
RAM : DDR3 SO, 2 GBYTE @ 1033MHz Std.
DDR3 SO,16 GBYTE @ 1033MHz Max.
PSU : 300W Standard
PCI-e : 1 slot used for telecom line Interface card or GLAN card

2.5.4. Hard drive

INTERFACE : SATA3 6GBIT/SEC
SIZE : 3.5 INCH
RPM : 7200
CACHE : 64MByte
QUALITY GRADE : 24/7
CAPACITY : 1 TBYTE
RAID : NOT SUPPORTED
BACKUP DRIVE : NOT SUPPORTED

2.5.5. Supported PCIe interface cards

ANALOG : SYNWAY TYPE ATP-24A/PCIe+/2.0 : 8CH max.
SYNWAY TYPE ATP-24A/PCIe+/3.0 : 8CH max.
TDM : SYNWAY TYPE DST-24B/PCIe+/2.0 : 8CH max.

2.5.6. Environmental specification

TEMPERATURE : +10....+35 °C (Operating) or -10....+ 65 °C (Storage)
HUMIDITY : 8%-90% No condensing, operating and storage.

2.5.7. Approvals

EMC APPROVAL : EN55022 / EN55024 / FCC15
SAFETY : EN60950

2.6. The APRESA-Compact (VoIP-only)



2.6.1. Specifications

2.6.2. Enclosure

TYPE	: NUC - type
COLOR	: BLACK
WEIGHT	: 2 Kg
DIMENSIONS	
-Height	: 40 mm
-Width	: 140 mm
-Depth	: 130 mm
# 2.5" DRIVES	: 1 INTERNAL
# USB	: 4 pcs placed on front side
COOLING	: Passive cooling.
CONTROLS	: -ON/OFF Switch
INDICATORS	: -Power (Blue LED) -Hard drive ACTIVITY (red LED)

2.6.3. Motherboard / CPU / RAM / PSU

MOTHERBOARD	: XCY
CPU	: INTEL 2810/2840, 64bit, Dual Core 2 x 2.0GHz, 1MB cache (for all specifications: www.intel.com)
RAM	: DDR3 SO, 2 GBYTE @ 1033MHz Std. DDR3 SO, 8 GBYTE @ 1033MHz Max.
PSU	: 60W Standard
PCI-e	: not available

2.6.4. Hard drive

INTERFACE	: SATA 3GBIT/SEC
SIZE	: 2.5 INCH
RPM	: 5400
CACHE	: 128MByte
QUALITY GRADE	: 24/7
CAPACITY	: 1 TBYTE

RAID : NOT SUPPORTED
BACKUP DRIVE : NOT SUPPORTED

2.6.5. Environmental specification

TEMPERATURE : +10...+35 °C (Operating) or -10...+ 65 °C (Storage)
HUMIDITY : 8%-90% No condensing, operating and storage.

2.6.6. Approvals

EMC APPROVAL : EN55022 / EN55024 / FCC15
SAFETY : EN60950

APRESA BASE Software

This chapter describes the complete procedure to install the APRESA base software image on a USB memory stick to a server PC

Pre-requisites:

- USB Stick + MONITOR + KEYBOARD + ETHERNET+ MOUSE
- APRESA Base License, Channel License(s), G.729 License(s), S&U License etc.
- WORK-PC (for processing the Licenses and the WEB configuration of the APRESA server)
- Interface cards as applicable.

If you have purchased the complete “VIDICODE made” APRESA server can skip this chapter. Your product will be delivered with software installed and all purchased channel licenses nicely activated. Follow this procedure for full re-installation only.

Typically, this procedure is written to support you if you have purchased the APRESA Base Software license (inherently without server hardware). This chapter contains all the supporting information that is needed to implement the APRESA software package on the server hardware of your choice.

The APRESA software runs under the LINUX Debian 11 operating system and needs a 64Bit X86 / Server PC environment.

Because APRESA offers great flexibility in number of recording channels, VoIP taps, digital taps, analog taps etc., the hardware requirements depend mainly on the scale of the recording system to be build. Also, the spare capacity issue for future expansion must be taken in consideration.

If your system utilizes hardware RAID, please refer to chapter 9 for more information.

Note: If your system will be built on a hardware RAID solution you have configure the RAID volume FIRST, before installing the Apresa base software.

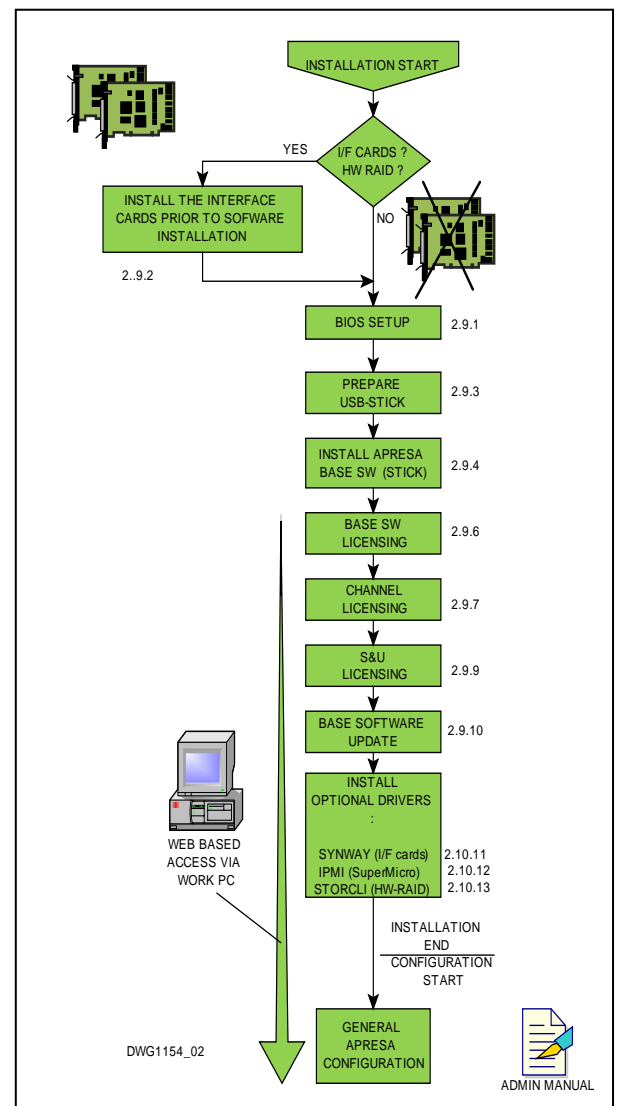

An APRESA that records only VoIP channels is a truly “Software only” solution.

Recording POTS, ISDN, TDM etc. however require interface card(s) built in your target machine.

INSTALLA



2.7. Hardware requirements

To support customers in the selection of the server hardware we offer a guiding list in a separate Quick Guide, named ' CALL RECORDER APRESA, Server Hardware requirements (VC1927) '

2.8. Interface card installation procedure

(Skip this chapter if you are working on a VoIP-only system inherently without interface cards)

The interface cards are all PCI-e based PC expansion cards.



BEFORE INSTALLATION OF THE INTERFACE CARD(S) ALWAYS:

- SHUT DOWN THE SYSTEM
- REMOVE MAIN CORD (-s)
- DISCONNECT ALL PERIPHERALS
- WORK IN AN ESD SAFE ENVIRONMENT

Procedure in detail:

- Simply push the ON/OFF button on front of the Apresa or shutdown the APRESA by using the WEB page (LOGON, ->TOOL->SYSTEM->SHUTDOWN (The shutdown may take some time so wait patiently until the red power LED turns off).
- After this controlled power down, disconnect the mains power plug (note: in case the APRESA is equipped with redundant power facility, remove BOTH mains power plugs)
- Open the chassis by removing the screws of the top cover plate to gain access to the PCIe expansion slots. (only for VIDICODE, other vendor hardware may be opened differently, refer to the documentation supplied by your typical hardware vendor)
- Locate a free PCIe slot to accommodate the interface card you want to install.
- Unscrew the blind plate bracket that corresponds with the PCIe expansion slot to use.
- Mark the type of card (like POTS, TDM etc.) for future reference.
- Carefully insert the interface card accurately in the PCIe expansion slot and lock the card-bracket using the screw. In case the interface card has a RJ21 type connector check both its bail locks to move freely outside the housing prior to fixation.
- Optionally you can add the top-bracket to secure the interface card firmly in the PCIe socket. Doing this is important with the (older) long interface cards. All new interface cards are quite short and will be mechanically fixed stable enough by only the card-bracket screw.
- Reposition the top cover and fixate the screws.

APRESA can take a number of interface cards depending on the specifications of the motherboard and the chassis.

F.i. :

SuperMicro X11SCL-F	: 3 slots PCIe so totally max. 3 cards.
SuperMicro X11SSL-F	: 3 slots PCIe so totally max. 3 cards.
SuperMicro X11SSM-F	: 4 slots PCIe so totally max. 4 cards.
ASROCK JQ1900B-ITX	: 1 slot PCIe so totally max. 1 ATP/DST card & limited to max 8ch.

2.9. Apresa Base Software installation procedure by using a USB stick.

THE USB-STICK IMAGE USED BY THIS INSTALLATION PROCEDURE CONTAINS
- THE LINUX 64BIT OPERATING SYSTEM
AND
- THE PROPRIETARY APRESA APPLICATION SOFTWARE



IF THE SYSTEM USES ONE OR MORE INTERFACE CARDS ALWAYS
INSTALL THESE CARDS
PRIOR TO BASE SOFTWARE INSTALLATION

IF THE SYSTEM USES HARDWARE RAID ALWAYS
CONFIGURE THE RAID VOLUME PRIOR TO BASE SOFTWARE INSTALLATION

2.9.1. BIOS setup

Attach monitor & keyboard & Mouse.

(Note: Controls used below refer to Phoenix BIOS, other BIOS manufacturers may be different)

Enter the BIOS configuration menu by pushing **DEL** repeatedly, directly after power on. This can take up to 1 minute for motherboards equipped with IPMI.

Select: **“GENERAL SETTINGS “**

- SET: DATE & TIME.

Select: **“BOOT SETTINGS “**

- SET: boot-sequence to BOOT from the Apresa installation drive.



When installing the software RAID 1 or software RAID 10 version of
APRESA you must set the BIOS-setting for RAID to
NO RAID
(RAID is handled by software)

-CSM (compatibility service module)

-> must be set to 'DISABLED'.

- Boot mode

-> must be set to 'UEFI

Note : Installation with CSM 'Enabled' and Boot Mode 'MBR' can be used if UEFI installation fails, Apresa will then be installed using the older MBR.

There may be other important BIOS setting to consider depending on your MOBO / BIOS manufacturer, like the 'Power on AC/MAINS lost' feature.

Select: "SAVE & EXIT" (enter: **F10** & **Y**)

2.9.2. Preparations

First, you need a common USB-stick (>2GB) to setup a bootable Apresa Base Software USB stick. A 'how to' guide is listed below.

The APRESA quick guide lists the Vidicode WEB-link to the latest APRESA BASE SOFTWARE ISO-Image that must be used to write a bootable USB stick containing all necessary Apresa installation files.

Ask VIDICODE sales for a "APRESA Quick Guide" if you don't have one at hand. One single image supports all APRESA configurations (NORAID/Software RAID/Hardware RAID/Encryption).

Alternatively, you can use DVD writer software to burn the image to a DVD and create an APRESA installation DVD. This however, is not recommended due to the e-waste and the slower installation progress. A nice freeware CD-burner-tool can be downloaded from <http://www.imgburn.com>.

When using hardware RAID, you must configure a hardware RAID volume prior to APRESA Base Software Installation. For the Vidicode approved Hardware RAID controller type & configuration support please refer to chapter 10 of this manual.

HARD DRIVE CONFIGURATION	Pcs OF HARD DRIVE REQUIRED
NO RAID	1
RAID 1	2
RAID 5 (depreciated)	3 or more
RAID 10	4

With Apresa base software installation with hardware RAID, you must choose the 'Standard' version, NOT the 'Software RAID' versions.

We will proceed by taking the next steps:

- Prepare a bootable USB-Stick for Apresa Base Software Installation;
- Apresa Base Software Installation using the USB-stick;
- Access the Apresa for the first time;
- Base software licensing;
- Channel licensing;
- SYNWAY driver installation;
- S&U licensing;

- Base software update;
- Install the IPMI driver (only when a SuperMicro MOBO is used);
- Install the storcli reporting tool (only when Hardware RAID is used);
- Apresa user configuration.

2.9.3. Prepare a bootable USB-Stick for Apresa Base Software Installation.

The traditional way of installing the Apresa base software is to create a CD/DVD using a .ISO installation image. Today we prefer the easier and faster approach and use a bootable USB-Stick.

What we need is 1) a 2GB or larger USB-Stick and 2) a freeware utility named 'RUFUS'.

The Work Flow :

1. Download RUFUS (<https://rufus-usb.en.uptodown.com/windows>)
RUFUS comes as a single executable file that can be run without installation.
2. In your browser, go to the 'Download' map, Click 'History' and click on 'RUFUS Vx.y'.

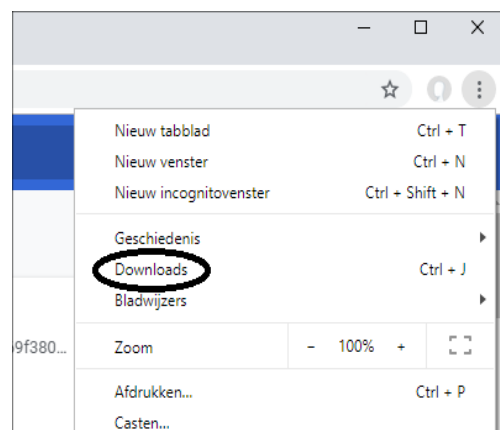
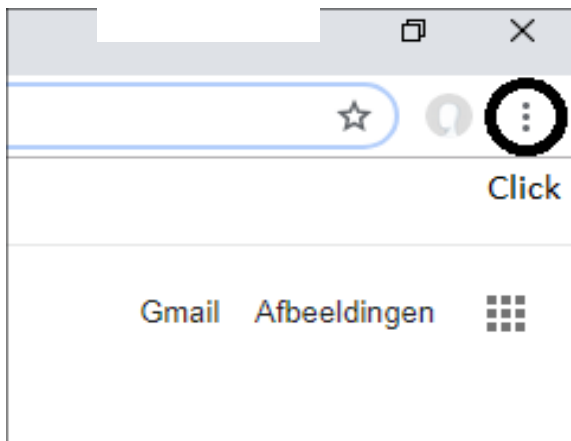

3. Rufus will start, a few selections must be made first:

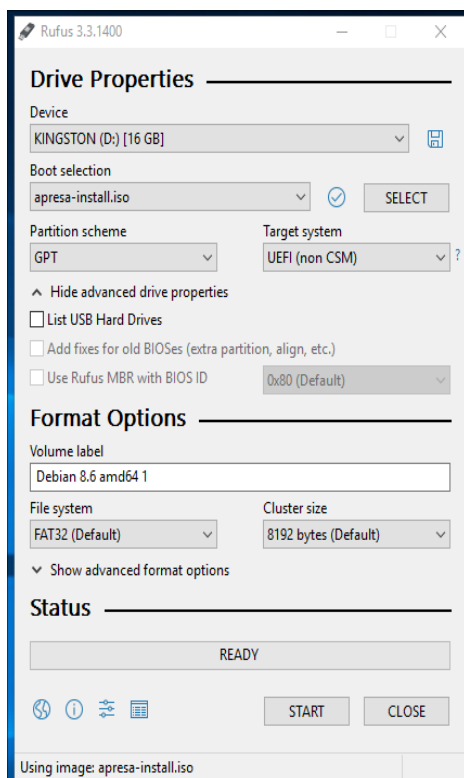

Device: Select the USB-Stick to use.

Boot selection: 'Select Disk or ISO image'.

Click select: select the the Apresa-install .ISO.

Partition scheme: Select 'GPT'.

The Other selects stay at their defaults.

3. Generate the bootable image on the USB-Stick by pressing the 'START' button.
4. Rufus will see that the Apresa-Image is actually a ISO-Hybrid and popup another

question about the writing mode to use , select 'Write in DD Image mode'.

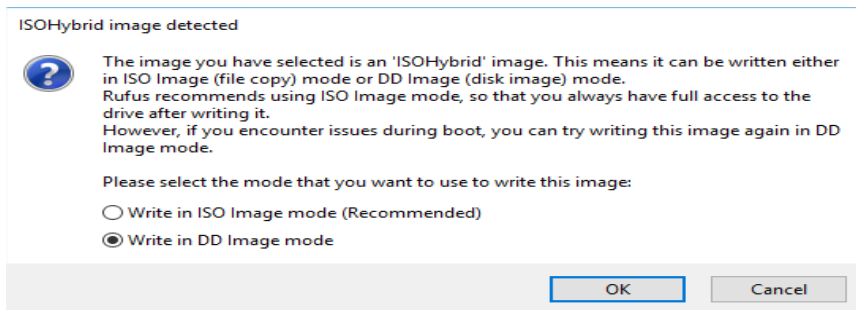

Click 'OK'

5. Confirm that it is safe to format the USB-Stick, as all data on it will be lost.

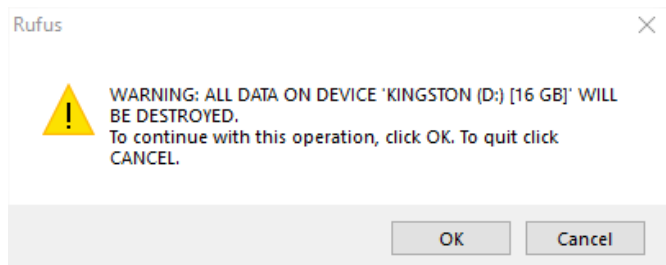

Click 'OK'

6. RUFUS will take sub-minute to process.

READY!

Your bootable Apresa USB-Stick is ready for use.

2.9.4. Apresa Base Software Installation using the USB-stick

Insert the APRESA installation USB-Stick in the APRESA server and restart the system. The installation process should start automatically. If installation does not start, make sure the USB-Stick is in the bootable devices list (Check BIOS setting: list of bootable devices). As an alternative one can make a manual selection for booting from USB-Stick by pressing F8 or F11 (depends on BIOS-brand) quickly after power-on.

After a while, the following screen is presented:

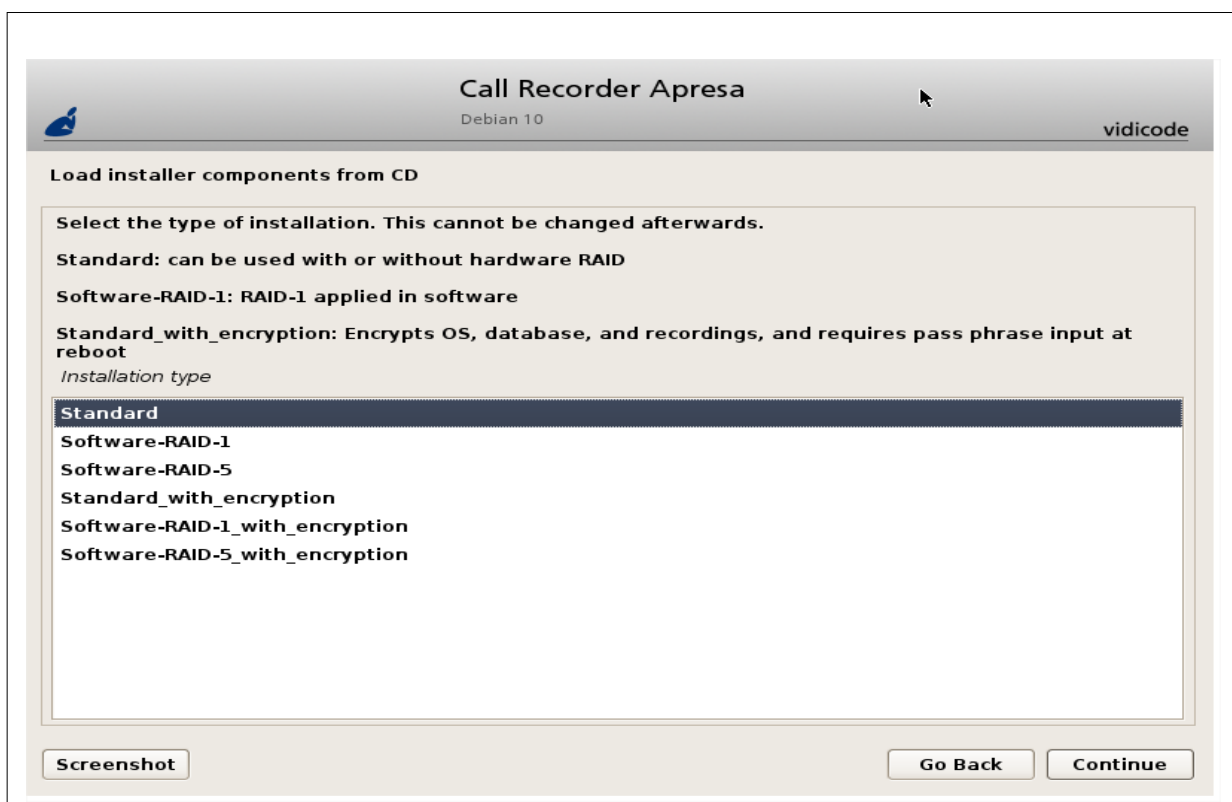

Select the desired APRESA version to install, just by selecting one from the list.



For systems equipped with HARDWARE RAID select 'Standard' or 'Standard with encryption' only.



Full disk encryption can be chosen during installation, and it will encrypt everything on the hard disk except the boot sector. Full disk encryption cannot be disabled or enabled later on. During reboot, it requires that a pass phrase is entered with a keyboard (connected directly to the system), in order to unlock and start the system. If the pass phrase is lost, it is impossible to recover the data, or even to start the system.



There are serious reasons to NOT deploy RAID5.
Please refer to the chapter about RAID deployment

After a while, when asked for, confirm the partitioning of the hard drive.

If you counter a prompt for 'Force UEFI?', your reply should be: 'Yes' as UEFI is preferred for Apresa. UEFI is state-of-the-art, safer and allows for larger hard drive storage compared to MBR.

After a while, when asked for, confirm the partitioning schema and allow writing of that schema to the hard drive.

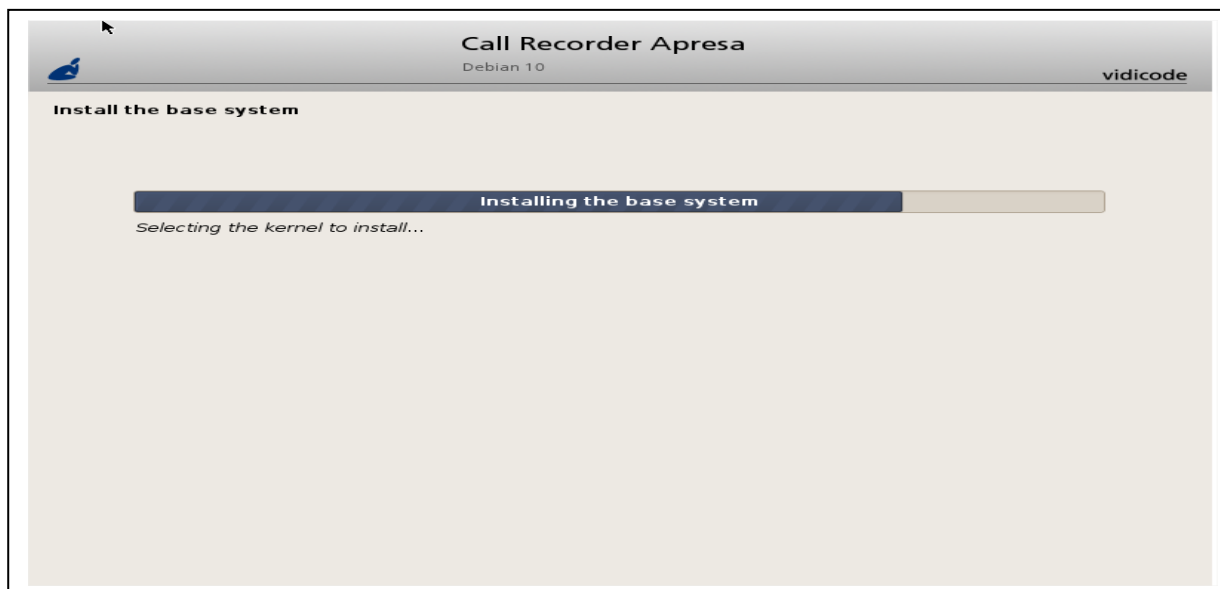

From this point on the installation should proceed automatically without further user interaction.

The installation process usually takes less than 20-60 minutes depending on the hardware performance of the server used. The end of the installation process is signaled by the 'System Halted' message displayed on the monitor.

2.9.5. Access the Apresa for the first time

Now, connect the APRESA system to Ethernet. On the VIDICODE-made APRESA hardware, this slot is marked with “LAN”.

Remove the USB Flash, we will not need it anymore.

Then, restart the APRESA system by pushing the ‘RESET’ button or by toggling the mains power(s). The system should now make a first boot of the newly installed APRESA application. If the system uses RAID, the hard drives synchronizing process will start automatically. Depending on the size and speed of the hard drives, synchronization may take several minutes to hours to complete.

Allow the hard drive synchronization to finish without power interruption. During synchronization, the APRESA can be accessed for further configuration, there is no need to wait here.

The following text helps you to access the Apresa web server so you can proceed the installation there as we are not finished yet.

There are two ways to access APRESA for configuration:

1. Over the LAN, using a web-browser on a separate PC to interface the Apresa web-server. This method requires the user (you) to set the LAN settings of the PC to include the network segment used by the Apresa by default. The Apresa is default on IP 192.168.55.55. How to connect is explained in more detail later in this section.
or,
2. Directly in the APRESA system shell. This is the preferred method, with the keyboard, mouse & monitor directly attached to the APRESA. First step is to login to the APRESA with user ‘vidi’ and password ‘brsRmbf’. Then enter Apresa web interface by the command ‘web’. You can skip the rest of this section and proceed APRESA installation at ‘APRESA BASE SOFTWARE license activation”.

The next section helps you in setting up the web connection to the APRESA by means of and a web browser on your work PC over the LAN.

The WEB interface over LAN is primary for normal client use but can also serve the configuration.

After the software installation, the APRESA has a STATIC IP address:

IP (STATIC)	= 192.168. 55. 55
SUBNET MASK	= 255.255.255. 0

Static settings make it easy to find the APRESA on Ethernet but note:

TO ACCESS THE WEB-INTERFACE OF THE APRESA YOUR PC MUST HAVE AN IP-ADDRESS IN THE SAME IP-SUBNET AS THE APRESA

Define the APRESA IP on the work PC

To access the APRESA web interface, you need to configure your work PC to have an IP address in the same subnet as the APRESA system. This means that your work PC should have an IP address assigned in the range from 192.168.55.1 to 192.168.55.254, for example 192.168.55.10. Don't use 192.168.55.55 as that is already assigned by default to the Apresa.

The network settings can be set at :

- Open the list of Network Connections (Windows Control Panel)
- Select your network connection, right-click and select Properties
- Select "Internet Protocol Version 4 (TCP/IPv4)" and click "Properties".

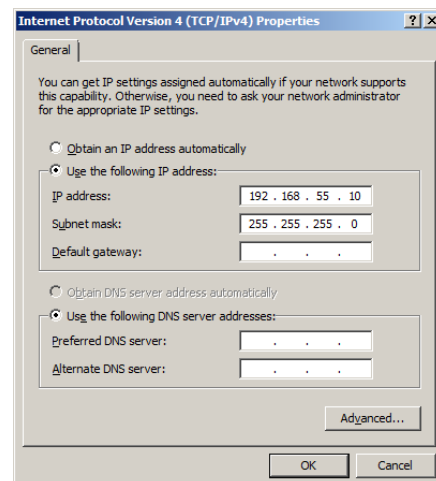

You should see something like the screen displayed on the right.

A. If "Obtain an IP address automatically" is enabled, then it is necessary to switch temporarily to a static IP address, as follows:

- Enable "Use the following IP address"
- As IP address, fill in: 192.168.55.10. (or any free IP 192.168.55.xxx)
- As Subnet mask, fill in: 255.255.255.0

B. If the PC was already set to a static IP address, but in another subnet, then it is possible to add an extra IP address to the PC configuration.

- Click "Advanced..."
- Click "Add..." in the IP address box (not the gateways)
- As IP address, fill in: 192.168.55.10.
- As Subnet mask, fill in: 255.255.255.0

After this adjustment, it should be possible to access the APRESA web interface from the PC. Test this by sending a ping 192.168.55.55, you should get a response.

APRESA Login

To access the web interface, start the web browser, and browse to <http://192.168.55.55>
The Log on screen of the APRESA web interface opens:

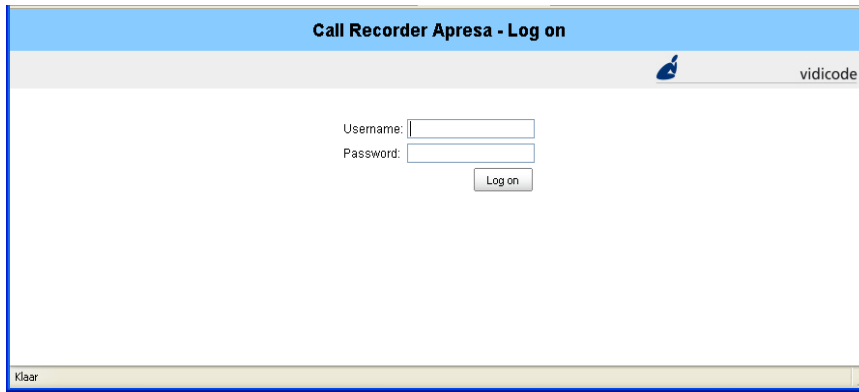

Note: This installation manual was originally written when Vidicode was distributing the 2011 version of the Apresa software. Consequently, some references and screenshots are targeted to that version. When running later versions, your screens may look slightly different.

The primary account username is “admin”.

The password to this account by default is “admin”.

The account ‘admin’ is the primary account for system administration.

First time APRESA network configuration

It is important to change the default assigned static IP network address of the APRESA system either to another static IP or use a dynamic IP.

The MAC address, if needed for DHCP configuration, can be found as follows:

- In the **Tools** menu, choose **System**
- Click **System Information**

The MAC address relevant to the web interface is displayed after eth0.

The APRESA network configuration can be changed as follows:

- In the **Options** menu, select **System Settings**
- Move to the **Network** tab
- Adjust the network configuration to match that of the PC network in your organization.
- Click **Apply** and let the network restart

If after the restart, the new IP address of the Apresa is not known for some reason, the program Apresa IP Lookup can be used.

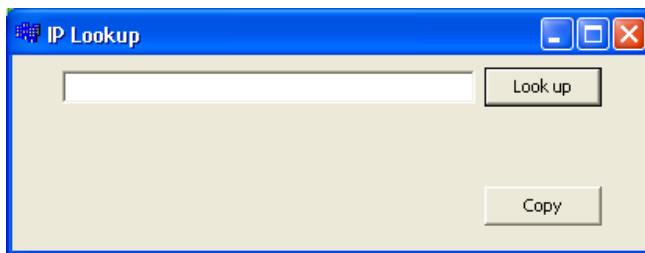

If this program cannot find the IP address, then the current IP address of the Apresa will be displayed on the monitor:

This Apresa machine has the following IP address: xxx.xxx.xxx.xxx

After this is completed, the network configuration adjustment for the PC that was discussed can be reversed.

2.9.6. BASE SOFTWARE Licensing

The diagram below shows the procedure to follow for the activation of the base license of the APRESA

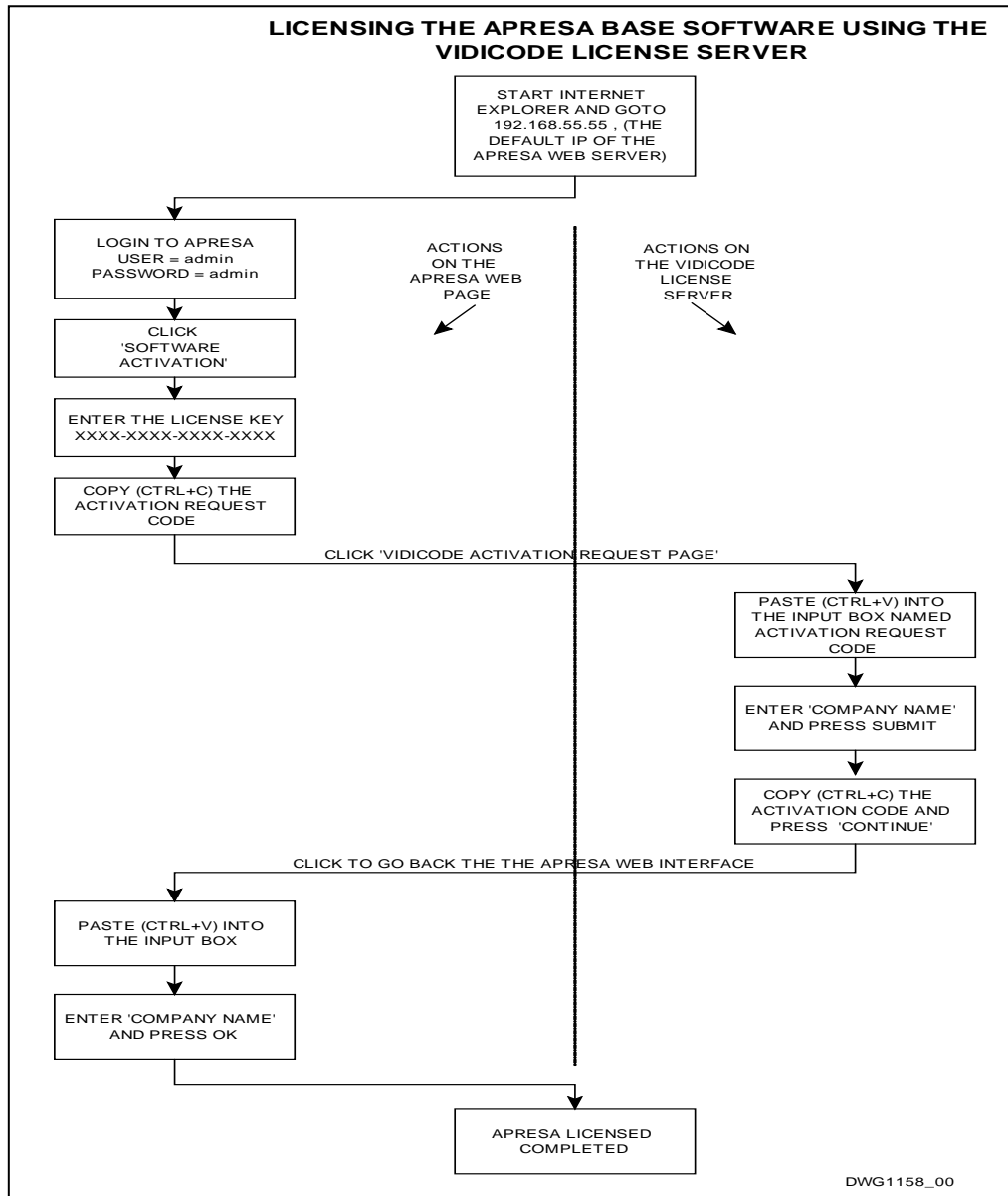

NOTE:

If you can't "click" on the APRESA web page to reach the VIDICODE license server go to:
<http://www.vidicode.com/activation>

In detail:

Start your web browser (e.g. Internet Explorer) and go to the IP address of the APRESA (192.168.55.55 by default). Enter Username & Password and click Log On.

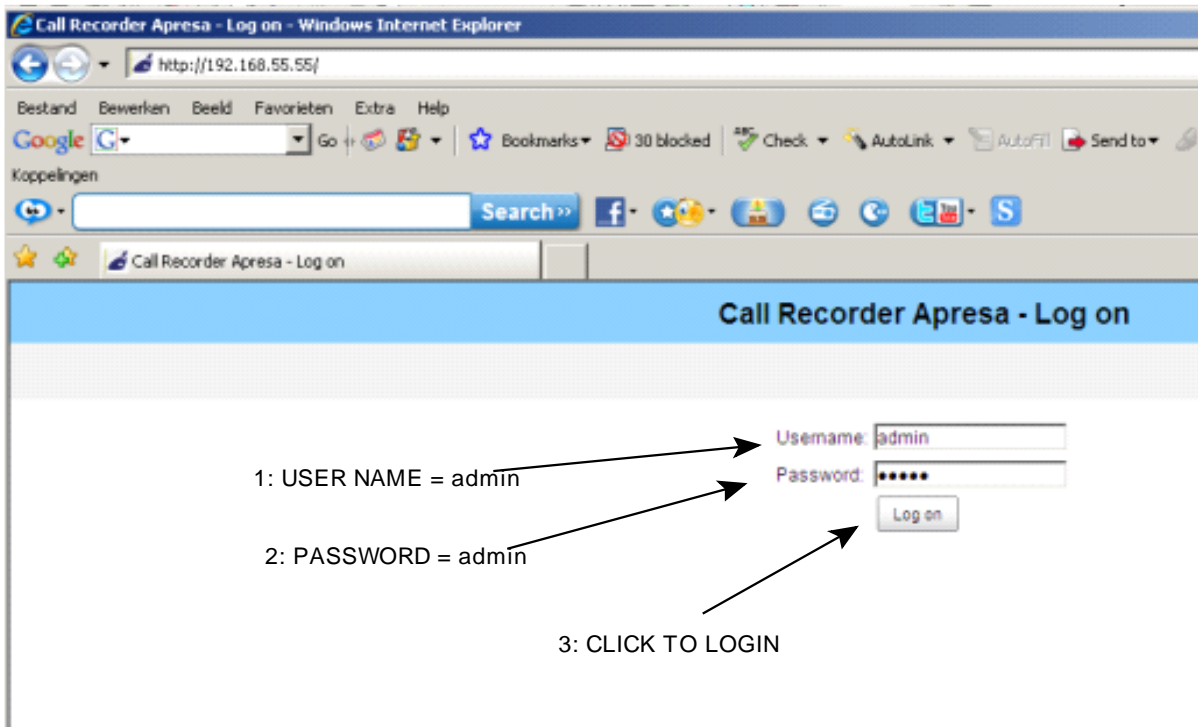

DWG1161_00

The 'Home' page will be displayed, see below. The page will notify that no license is activated yet. APRESA will ONLY record calls after proper licensing. Click on the link 'Software activation' to start the licensing procedure.

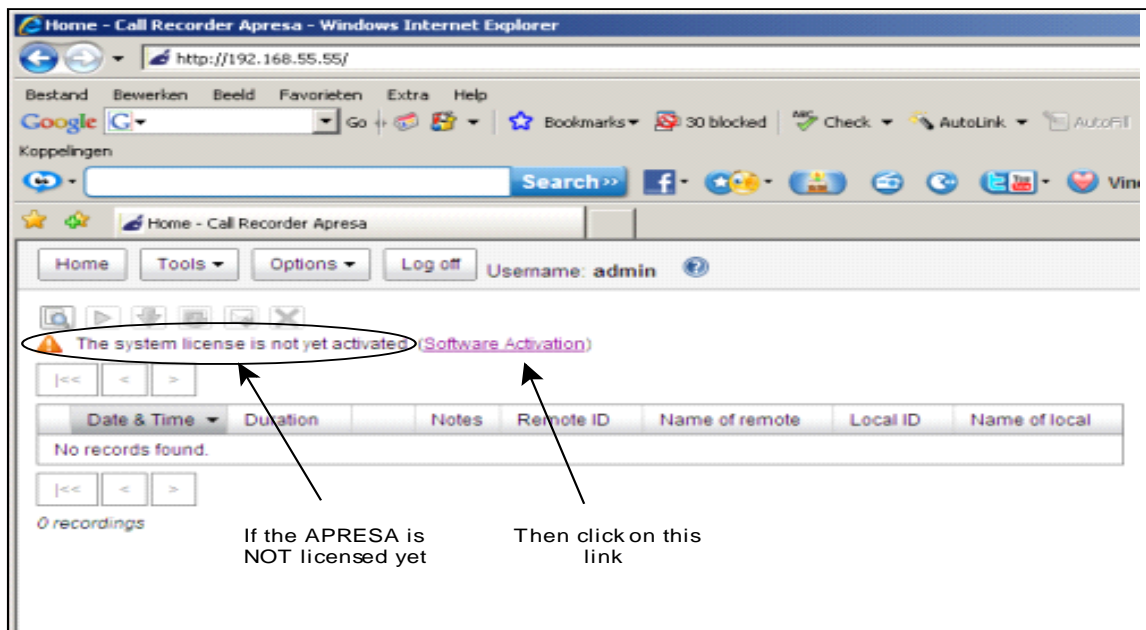

DWG1160_00

On the screen below, enter the license key and press ok

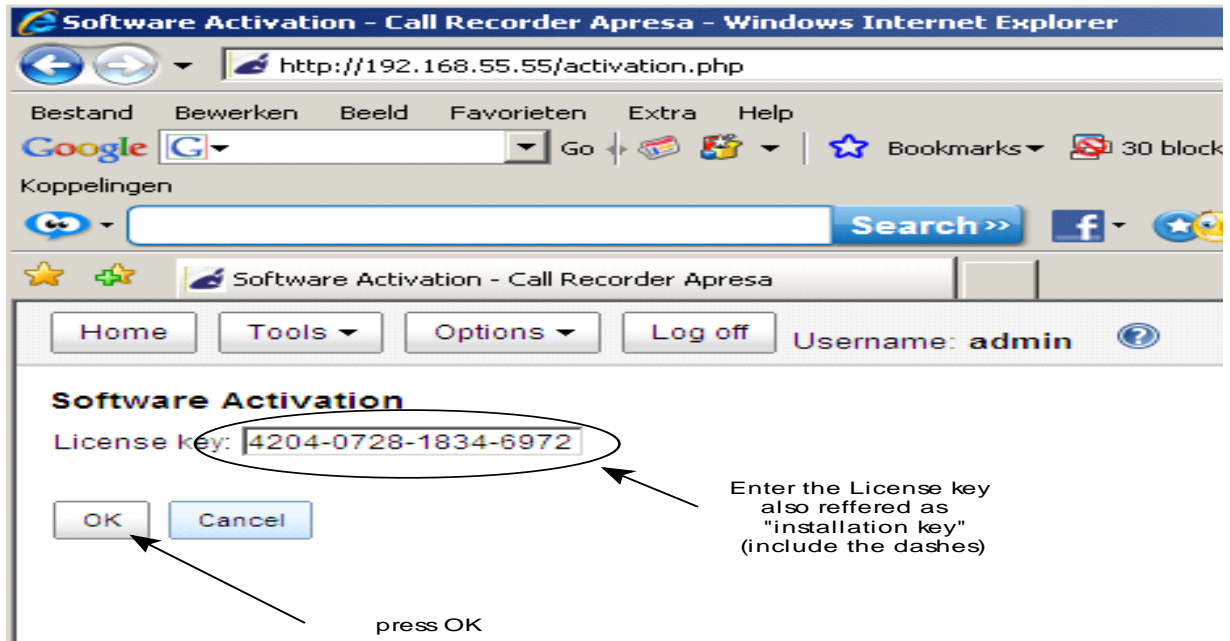

DWG1162_00

Next:

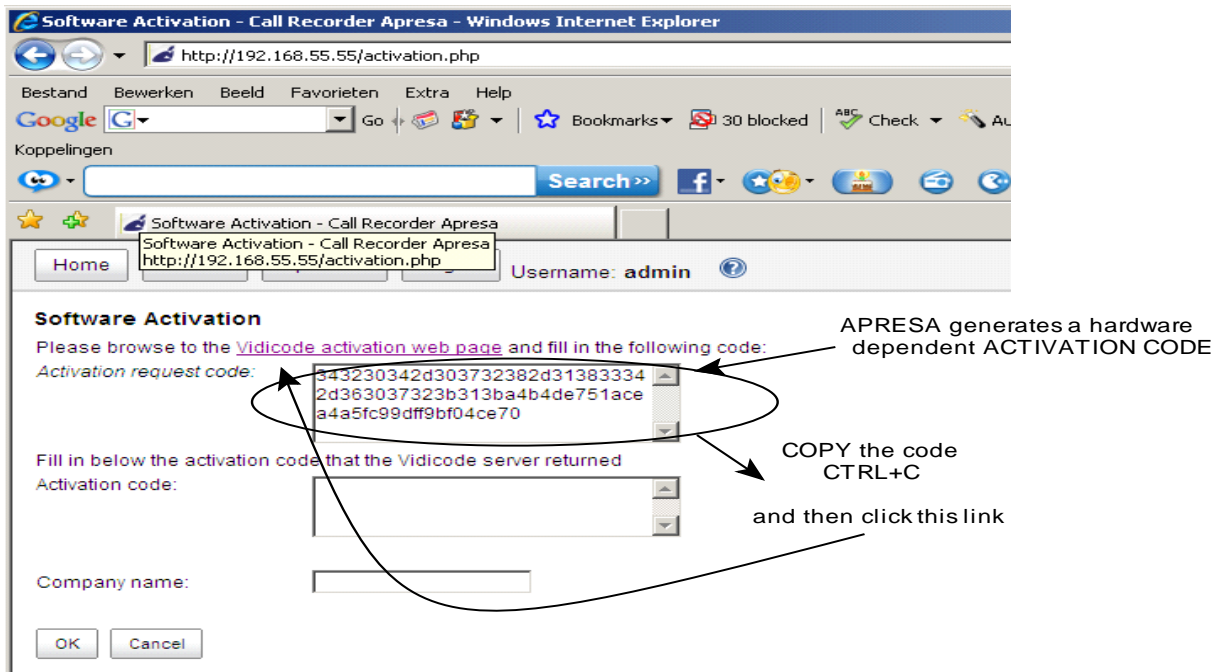

DWG1163_00

By clicking the link you will be connected to the VIDICODE license server WEB page.

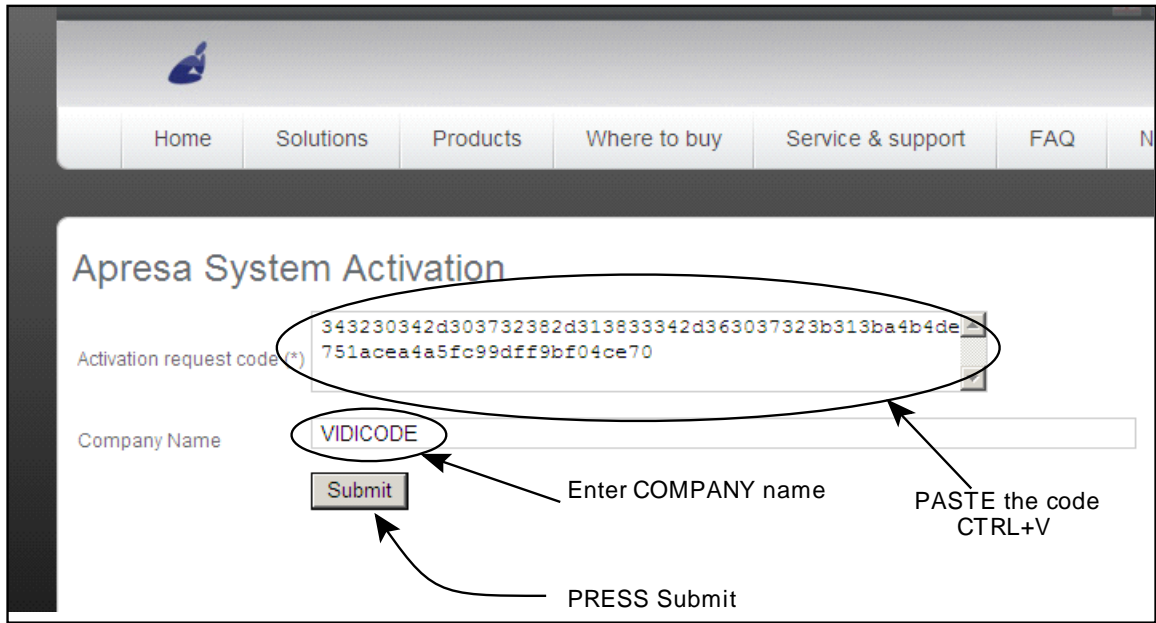

DWG1164_00

On the screen below copy the activation code (select then CTRL+C)

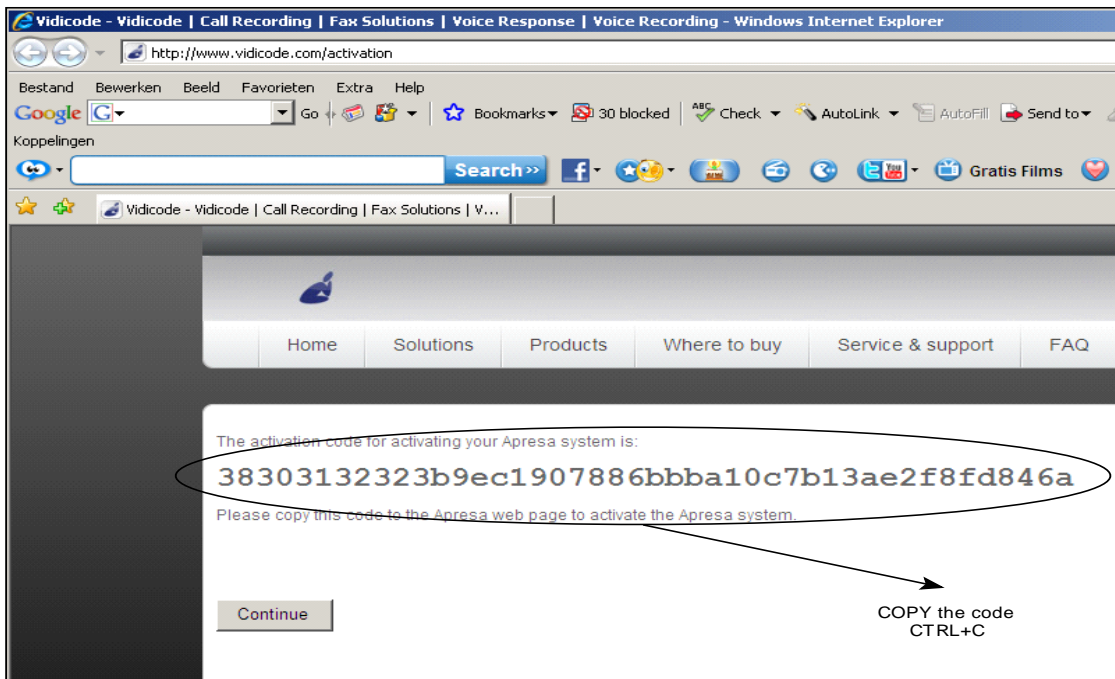

DWG1165_00

Now go back to the WEB page of the APRESA and paste (CTRL+V) the activation code. Enter the Company name, followed by ok.

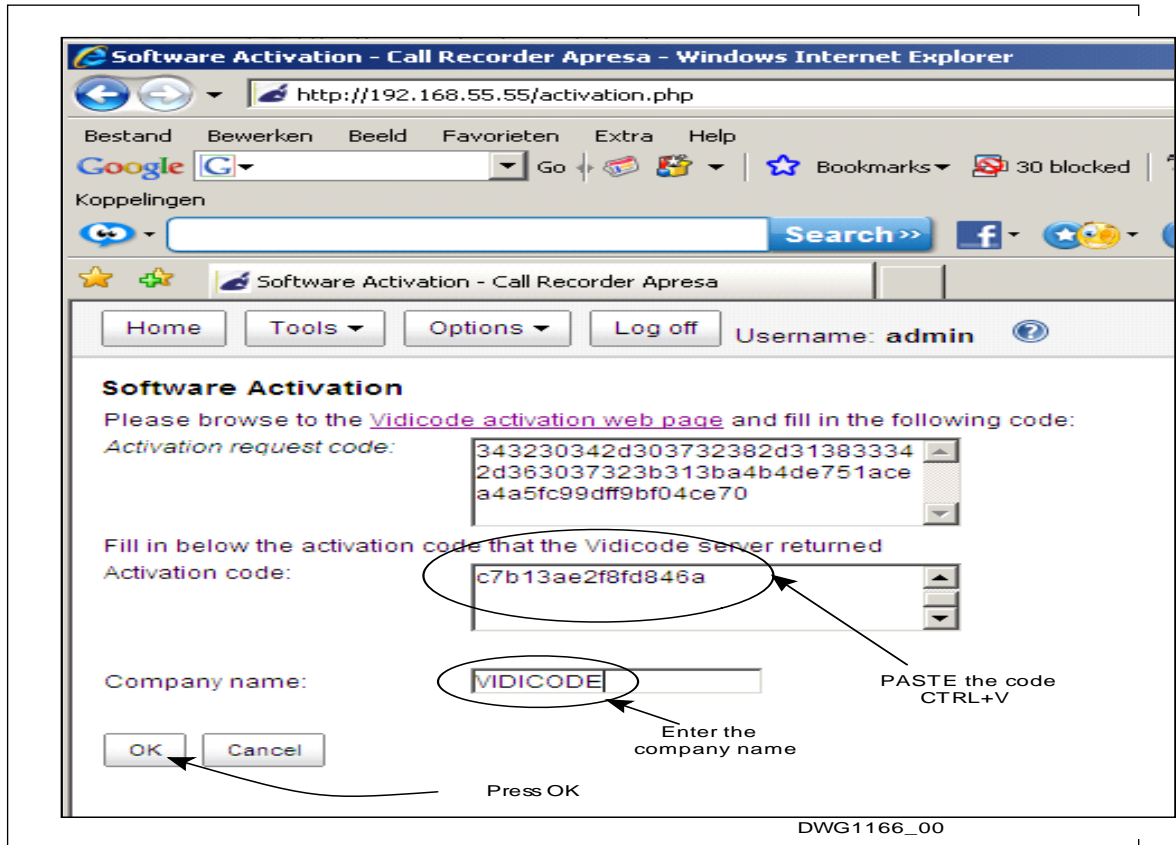

Now the activation is finalized.

To check the success of the activation, select from the APRESA main page:

Tools -> System -> System Information.

If the software serial number a realistic value (not 0 but a number larger then 80000) then the license is activated. Note that you need the software serial number to install recording channels on your APRESA. See the section "channel license activation".

2.9.7. Channel Licensing

The diagram below shows the path to follow for the activation of channel licenses on your Apresa:

(Channels can only be installed AFTER the installation of APRESA base software)

LICENSING RECORDING CHANNELS ON THE APRESA USING THE VIDICODE LICENSE SERVER

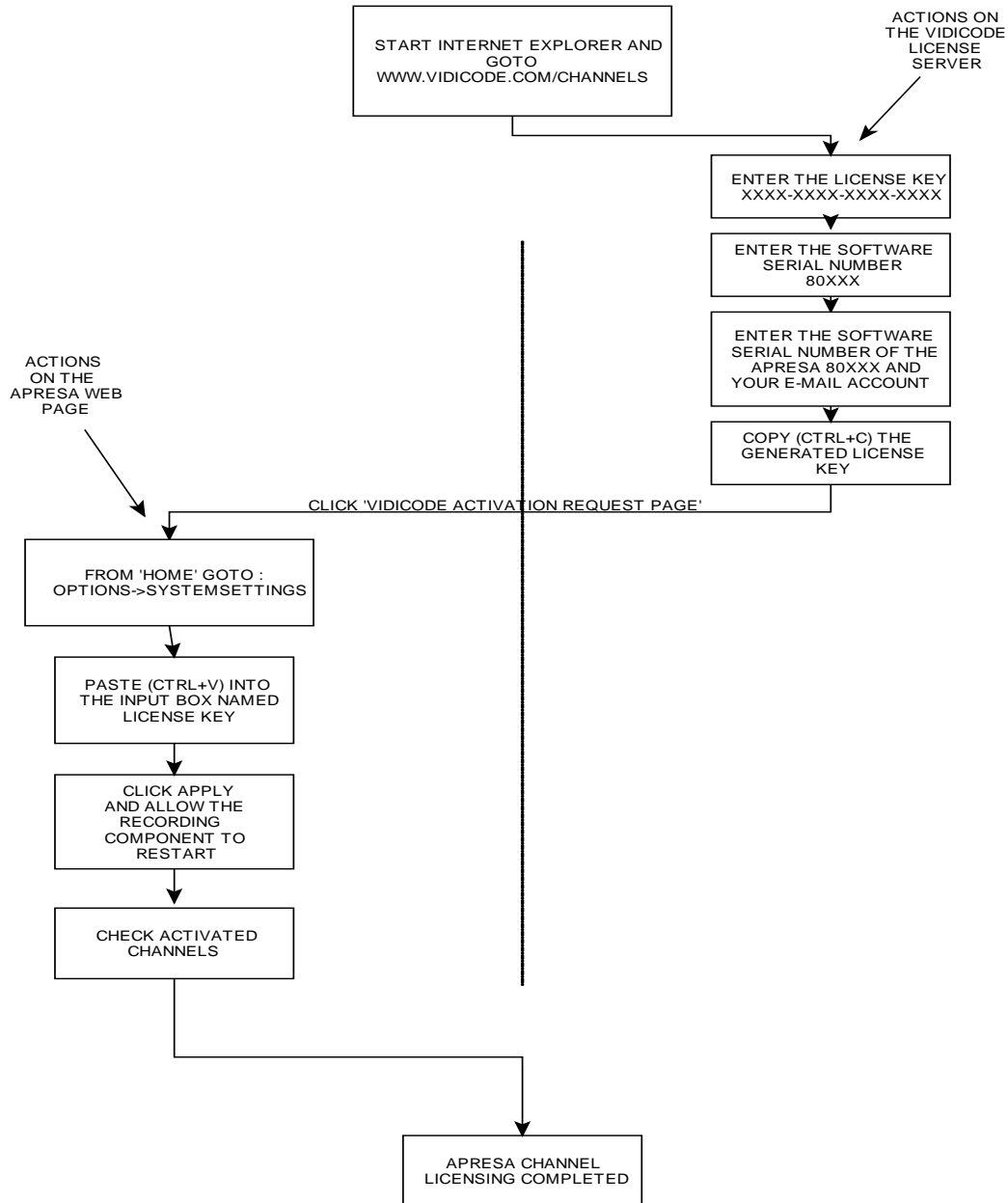

DWG1159_00

NOTE :

If you can't "click" on the APRESA web page to reach the VIDICODE license server go to : <http://www.vidicode.com/channels>

After the system license is activated, it is possible to activate the channel licenses that you have purchased. The system will not record until one or more channel licenses are installed.

- Go to the APRESA WEB-homepage, click: **Tools -> System -> System information** and copy (CTRL+C) the “Software serial number” that is displayed;
- Click **Options -> System settings > Activate new channel license**. This will open the VIDICODE channel license server on the internet;
- Enter the license key of the channel license (including the dashes);
- Paste (CTRL+V) the serial number of the machine;
- Optionally enter an e-mail address to send the generated license key;
- Click **Submit**
- Copy (CTRL+C) the generated license key that is displayed
- Move back to the APRESA web interface, and paste (CTRL+V) the key into the License key input box
- Press **Apply** and let the recording component restart.

On success, the number of channels should be updated and displayed in the APRESA web interface.

(click : **Tools -> System -> System information**)

The APRESA system is now ready for recording the new channel(s).

NOTE

The software and channel installation need no special attention regarding software drivers for the interface cards. All the interface card drivers are installed automatically and completely without user concern. So, for instance, if you change from SIEMENS to AVAYA TDM you don't have to install different interface card drivers. All you have to do is to change the setting to AVAYA. All PBX that are listed in the compatibility list can be selected without the need to change software drivers.

2.9.8. SYNWAY driver installation

This step can be skipped if your Apresa is ' VoIP - only ', but if Synway interface cards are deployed you must install the Synway Card I/F Driver manually.

First, check that all the Synway I/F cards are physically installed in your server. Then, run from the Apresa-WEB page: Tools->System->Install Driver. This, obviously, will install the

driver for the SYNWAY card(s). There is only one driver that services all ATP, DST and DTP.

2.9.9. S&U licensing

Just follow the quick guide that comes with the S&U license.

2.9.10. Base Software Update

1. Assure that the APRESA that you want to update has a valid S&U license;
2. Log in as administrator (admin) in the web interface;
3. Open the **Tools** menu, select **System**;
4. Click the **Software update** button;
 - 4-A. *When Apresa has internet connection*, click **Check for Update**. Then click **Download**. It will display a warning if calls are active now. Click **OK** if it is not a problem that these currently active calls will not be recorded. Depending on the speed of the internet connection, it might take a while to download the update.
Or...
 - 4-B. *When Apresa has no internet connection*, download the update file from <http://www.vidicode.com/softwupd/apresa-update.tgz> to your PC. In the Apresa web interface, select this file on your PC, and click **Upload**.
After the file uploaded, or after Apresa has downloaded the update itself, Apresa displays that it is updating the system. When finished, Apresa displays the message that the update is installed.
5. To check the currently installed version, open the **Tools** menu, and select **System**.

Note:

- 1- The update file works for the all hard drive configurations:
- 2- The update file works for the hard drive sizes: 1T / 2T / 3T

2.9.11. Install the IPMI driver

The SuperMicro motherboards have IPMI support that needs the driver:

add-ipmi-deb11.tgz

Note that this update is also required to have the status of the redundant power supplies reported.

Web location : <https://www.vidicode.com/support/add-ipmi-deb11.tgz>

The procedure for driver installation to follow is the same as for updating the base software, described earlier.

2.9.12. Install add-storcli

The management for hardware RAID (LSI family of RAID controllers) needs installation of:

`add-storcli.tgz`

The procedure for the tool installation to follow is the same as for updating the base software, described earlier.

Web location: <https://www.vidicode.com/support/add-storcli.tgz>

If 'System Information' shows an active tamper alarm the it must be set to 'Ignore'.

2.9.13. Help for installation of APRESA on Virtual Machines

For installation under "VM-WARE"

- Ask sales for the "Apresa VM-Ware Quick Guide";
- Check the correct APRESA ISO-file used for installation;
- Turn on the BIOS setting "virtual machine". (under device configuration or system security)

2.9.14. Help for installation of Apresa on an existing Debian machine (Cloud)

When renting a virtual machine in a data center with any (cloud) service provider, usually you do not have the option to install Apresa using the installation ISO. Instead you are probably given access to an already installed instance of Debian Linux. In this document, the procedure is described to install Apresa in such an environment.

Notice that since the virtual machine is not set up and fully controlled by the Apresa installation, we cannot guarantee the same functionality.

Retrieving and validating the installation package

- When creating the virtual machine, select Debian Linux version 11 (other distributions and versions are not supported currently)
- Get access to the shell, and login
- Retrieve the installation package from the internet

wget https://www.vidicode.com/support/apresa-install-debian11.tgz

If it says "command not found", then first install wget (**apt-get install wget**)

- The signature of the installation package can be used to verify if the package is from Vidicode.

wget https://www.vidicode.com/support/apresa-install-debian11.tgz.sig

gpg apresa-install-debian11.tgz.sig

The public key of Vidicode is found at the following places:

- /usr/share/apresa/vididev.pubkey on any existing Apresa installation
- On a key server: **gpg --recv-keys 4442F1408963693A**
- <https://www.vidicode.com/support/vididev.pubkey>

Installation

- Extract the installation pack
tar xzf apresa-install-debian11.tgz
If it says “command not found”, then first install tar (**apt-get install tar**).
- Run the installation (this step has to be done as root)
apresa-install/run.sh
After the installation process, you will be prompted to enter a new admin password for the web interface.

Security measures

Consider applying the following security measures, especially when Apresa is on the public internet.

- Restrict access using a firewall on Apresa or outside of it, based on IP address or other rules, or give access only through a VPN tunnel. Disable remote access to SSH, or allow access to SSH (port 22) only for your own IP address. This might be configurable in the network settings of your virtual machine as provided by your cloud service provider (e.g. Azure).
- Configure automatic security updates of Debian Linux (Tools > System > Software update)
- Use strong passwords for the web interface and use a strong password or key-based logon for SSH
- Enable two-factor authentication using email (System settings > System > Log on Verification Code)

2.9.15. General APRESA configuration

The next step is to configure the APRESA to meet the specific needs of the owner or organization. This is typically done by the assigned administrator employee. Please refer to the Admin manual for further instructions. The Admin manual can be found on the Application CD and on www.vidicode.com and www.callrecorderapresa.com

3. MOUNTING

This chapter describes the mounting of the “made by VIDICODE” version of the APRESA server. If you use another brand of server then things may be different in your situation.

A full APRESA installation involves the following steps:

- Choosing the location to install the unit;
- Fixing the unit on the selected location;
- Apply power;
- Telecom or network wiring.

3.1. *Location considerations*

The environmental requirements for reliable and safe operation of an APRESA server are in general quite standard for systems based on PC technology:

- Clean office environment / server room;
- Protection from direct sun light;
- Restricted access;
- Temperature 10-35 °C;
- No vibration;
- FLAT surface when used as desk top.

As the best location, we advise to install the APRESA server in your computer server room. Always install the APRESA server in close proximity of the PBX and phone patch panel as there are maximum cable length restrictions to deal with.

The APRESA call recorder is capable of recording various telephone systems:

- VoIP telephony;
- POTS telephony;
- TDM telephony;
- ISDN-2 telephony;
- ISDN-E1 or ISDN-T1 telephony;
- Or a combination of the systems above.

When an APRESA server is required to interface to various different telephone systems (e.g. VoIP and POTS combined) it may sometimes be difficult to meet all maximum cable length restrictions required by the various telephone systems. When you make trade-offs in cable planning realize that some systems are more forgiving / tolerant than others:

Less critical system in terms of wiring →

3.2. *Mounting APRESA into a 19-inch cabinet*

The APRESA server is designed to fit in standardized 19-inch server cabinets and will take 1U or 4U in height. Depending on the telecommunication system to be tapped up to 4 patch panels (each 1U in height) may be involved in the total installation and need to be considered when planning cabinet space.

The required cabinet depth is 45cm for the APRESA unit. For proper cable routing of you must reserve an extra 10cm wire routing space minimal.

The power consumption of the unit is low enough not to affect the thermal balance of the neighbor-equipment placed above and below. You must always check not to block the airflow on adjacent equipment. To be safe, just have 1U space unused on both sides of the APRESA.

For easy access after installation we advise to use the optional available sliders (ART 090.04090).

Use 4 sets of standard screws & cage nuts to fixate the APRESA in the 19"-RACK (not supplied).

3.3. *Apply power to the APRESA.*

**THIS EQUIPMENT MUST BE
EARTHED**

The APRESA can be powered from any (EARTHED !!) 90-260Vac mains outlet.
The APRESA Compact can be powered from any (EARTHED !!) 200-260Vac mains outlet.

The power consumption of the APRESA is labeled on the housing and is in the range of 80-120W, depending on interface cards- and storage (hard drive) options.

If the tapped communication system is powered by a UPS you may consider to feed the APRESA also from the UPS enabling sustained recordings to continue during power interruptions. Note that tapped telecommunication lines will not be influenced by a power down of the APRESA.

Critical applications may use a redundant power supply. This option is easily identified by 2 IEC mains power inlets at the back of the APRESA. Both inlets must be individually connected

to mains, preferably on different main groups in the electrical installation or different UPS-s. Refer to chapter 10 for more information on redundant power supplies.

The APRESA chassis should (and must) be grounded for safety reasons, according to standard industry requirements. A simple way to comply is using the third pin on the APRESA-PSU power inlet. Using a good quality standard (earthed) mains cable and insert it to an EARTHED mains source. Absent or improper grounding may cause instability in operation as well as unsafe situations.

4. TELECOM WIRING

4.1. Introduction

The APRESA can be used to record from a wide variety of different signal sources spanning from simple audio lines to the more complex ones like ISDN and VoIP networks.

In the table below you find the various source characteristics listed

OVERVIEW OF WIRING CHARACTERISTICS							
REF	AUDIO	ANALOG (POTS)	TDM (PBX<->TEL)	ISDN2 (BASIC RATE)	ISDN E1/T1 (PRIMARY RATE)	TETRA	VOIP
GROUP	NOT NETWORK BASED	TRADITIONAL TELEPHONE NETWORKS				LAN-BASED TELEPHONE NETWORKS	
INTERFACE CARD	ATP		DST		DTP	N/A	
WIRING	UTP, shielded	UTP (CAT3 or better)				100/1000 ETHERNET (CAT5)	
2/4 WIRE	2	2	2 OR 4	4	4	N/A	
CARD CONNECTOR	RJ21				1,2 or 4 x RJ45	RJ45	
RJ11 PATCH BOX	YES				NO		
TAPPING PATCHBOX	NO	YES			NO		
EXTRACTION	HIGH IMPEDANCE PASSIVE TAPPING					RTP MIRRORING	

Interface card

This parameter specifies the type of the interface card capable of capture the specific signal. The call recorder APRESA supports 3 types of interface cards:

ATP-type – Interface Cards:

-Interfaces to ANALOG signals. One card supports 8,16, or 24 channels.

DST-type - Interface Cards:

-Interfaces to DIGITAL (TDM or ISDN2) signals. One card supports 8,16, or 24 channels.

DTP-type – Interface Cards:

- Interfaces to DIGITAL signals. One card supports 1,2 or 4 trunk lines
= 30 channels E1 / trunk line or 24 channels for T1 / trunk line

Depending on the requirements of your implementation of APRESA, interface cards may be a necessary part of your system. APRESA can hold up to 6 interface cards as maximum by using extended motherboards. A special chapter is dedicated to the specification of the interface cards.

For TETRA and VOIP recording NO special interface card is needed. These networks are Ethernet based and both use the designated Ethernet port located on the PC motherboard.

WIRING

Type of wiring used. Note that for 'AUDIO' you have to make a technical choice depending on the situation at hand.

2 / 4 wire

This number specifies the number of wires to tap in order to record both/all participants in a conversation. Basically, this is the number of wires that is used to establish the communication link.

A 2-wire link is normally an unshielded twisted pair (UTP). A 4-wire link is normally built with 2 UTP-s, one for the UP-link and one for the DOWN-link.

Pay attention when tapping TDM, either 2- or 4-wire links are used by the different PBX manufacturers.

When interfacing 'AUDIO' you normally deal with a 2-wire connection with ONE source.

CARD CONNECTOR

This line lists the connector type on the APRESA server.

In case of RJ21 you can connect (by soldering) directly your signals to this connector. Also, a patch box is available to avoid soldering.

The RJ45 connectors on the DTP interface cards must be connected in parallel using a so called 'T' splitter

EXTRACTION

All interface cards mentioned extract the signals to be recorded based on 'high impedance tapping' meaning that the original signal is extracted with minimal electric disturbance. Depending on the type of PBX, the cable length between the APRESA recorder and the TAP-point (the "stub length") can be up to 6 to 20 meter.

For 'Audio' recording 'high impedance tapping' is not always wanted. Depending on the situation some kind of line-termination may be necessary.

When recording VoIP or TETRA, the 'Ethernet' based networks, you must configure port mirroring switches in order to feed the RTP packets to the APRESA VoIP Ethernet port.

RJ11 PATCHBOX

-Indicates the compatibility with the simple 24 channel RJ11 patch panel.

TAPPING PATCHBOX

-Indicates the compatibility with the splitting 24 channel Tapping Patch box.

4.2. Connector locations

The connectors involved with the telecom signals can all be found on the back side as shown in the example below (note that your hardware may look different):

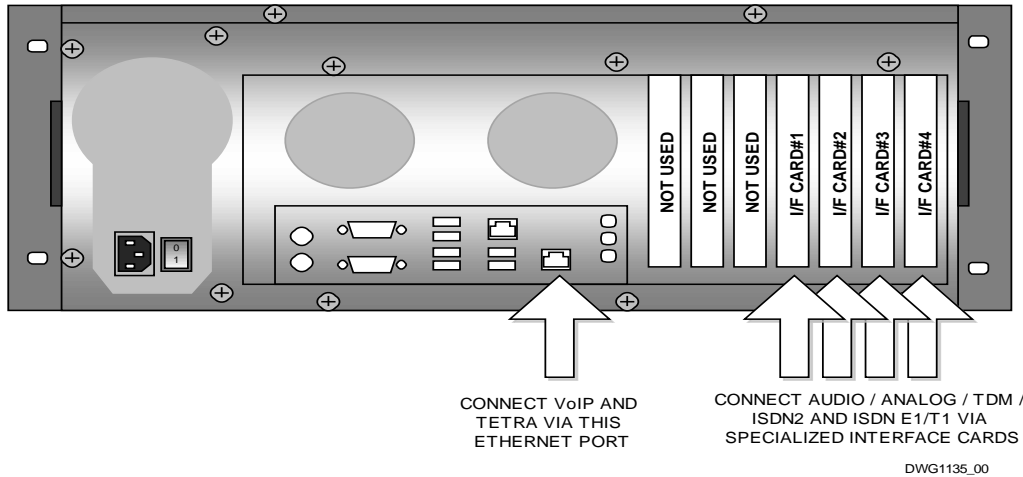

The VoIP and TETRA connections are of CAT5 / CAT6 Ethernet type. Thanks to the world-wide standardization, no serious wiring issues are expected. The focus with these networks is on the configuration of the network elements like switches and routers. Connect to the port labeled “VoIP”

All other (legacy) telecom infrastructure is interfaced via (optional) specialized interface cards. Depending on the existing wiring of telephone installation that must be tapped you can follow different paths to do the job right. The focus here is tracing the wires that carry the desired signal and how to make an easy TAP to feed the signal to the APRESA. Connect to the ports labeled “ANALOG”, “TDM”

In the next sections, you find the general remarks

4.3. General remarks about wiring

APRESA channels that use interface cards never deals with any line termination.

APRESA is generally installed to tap **existing** telecom networks where we have to deal with all kind of wiring systems, modern and old.

APRESA monitors the communication line to be recorded electrically “in parallel”. As a result, we will have to make “T” junctions. For the RJ-modular connection system one can use readily on the market available “T” splitters (RJ12 or RJ45)

4.4. Wiring audio TAPs

The interface-card that is used to make an AUDIO tap is the ATP-card. See chapter 13.1 for the specification and the connections of this type of interface card. This is also the wiring method for (mobile) communication transceivers used by police etc. These radios must have an audio output for the mixed microphone/speaker signal.

For the pin assignment of the RJ21connector **on the interface card** see the figure on the right. Every channel needs 2 wires CH-x-A and CH-x-B.

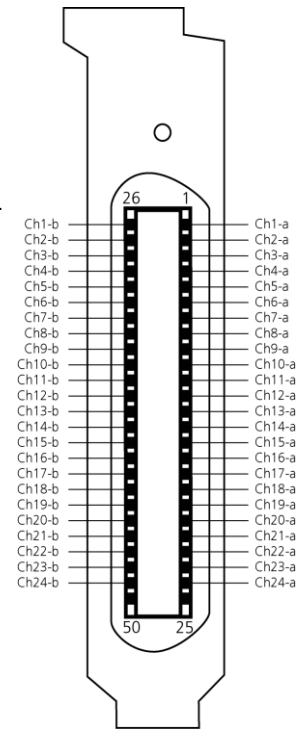

4.4.1. Balanced signals

It is preferred to feed balanced pairs to the interface card. This will give the best results in terms of hum and other distortion. Every analog input of the APRESA is built with individual line transformers and DC blocking capacitors, in a truly balanced

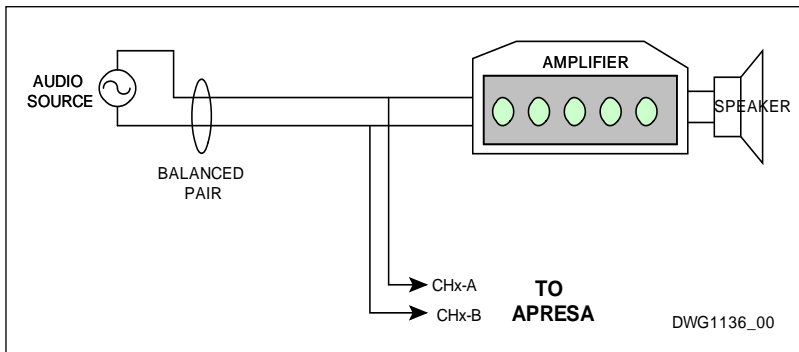

configuration.

The interface card will not provide any realistic line termination, so if the audio line is not terminated by other equipment (typically an amplifier) you probably want to add a line terminator in some situations. If you want, e.g. 600 ohms line termination then provide a 600-ohm termination resistor externally.

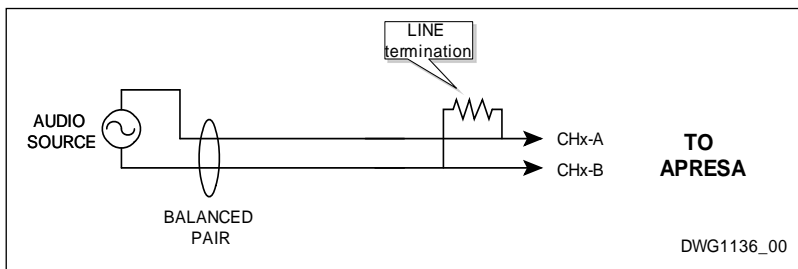

4.4.2. Un-balanced signals

Unbalanced signals (also called “single ended” signals) also have 2 wires, the signal wire and the ground wire. Because the channels on the analog interface card are isolated in respect to all other channels and to ground, connecting unbalanced signals is no different than the balanced connection type.

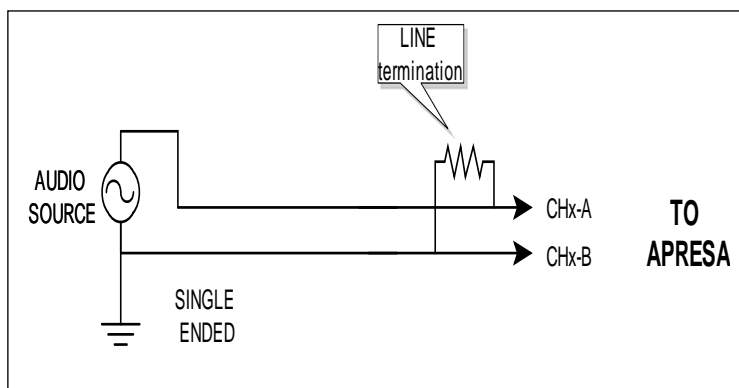

When dealing with an unbalanced signal we advise only to use the best quality of shielded cable that is kept as short as possible.

4.4.3. Wiring using the RJ11 Patch Box

To ease the wiring job, all analog interface boards are supplied with a RJ11 patch box and a RJ21/RJ21 cable 1meter in length. (Optionally lengths of 3,5 and 10m are available, but remember that shorter=better)

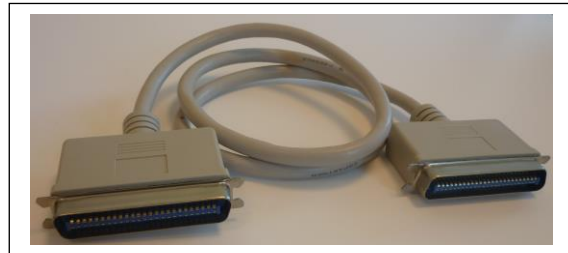

Connect the Patch Box to the APRESA:

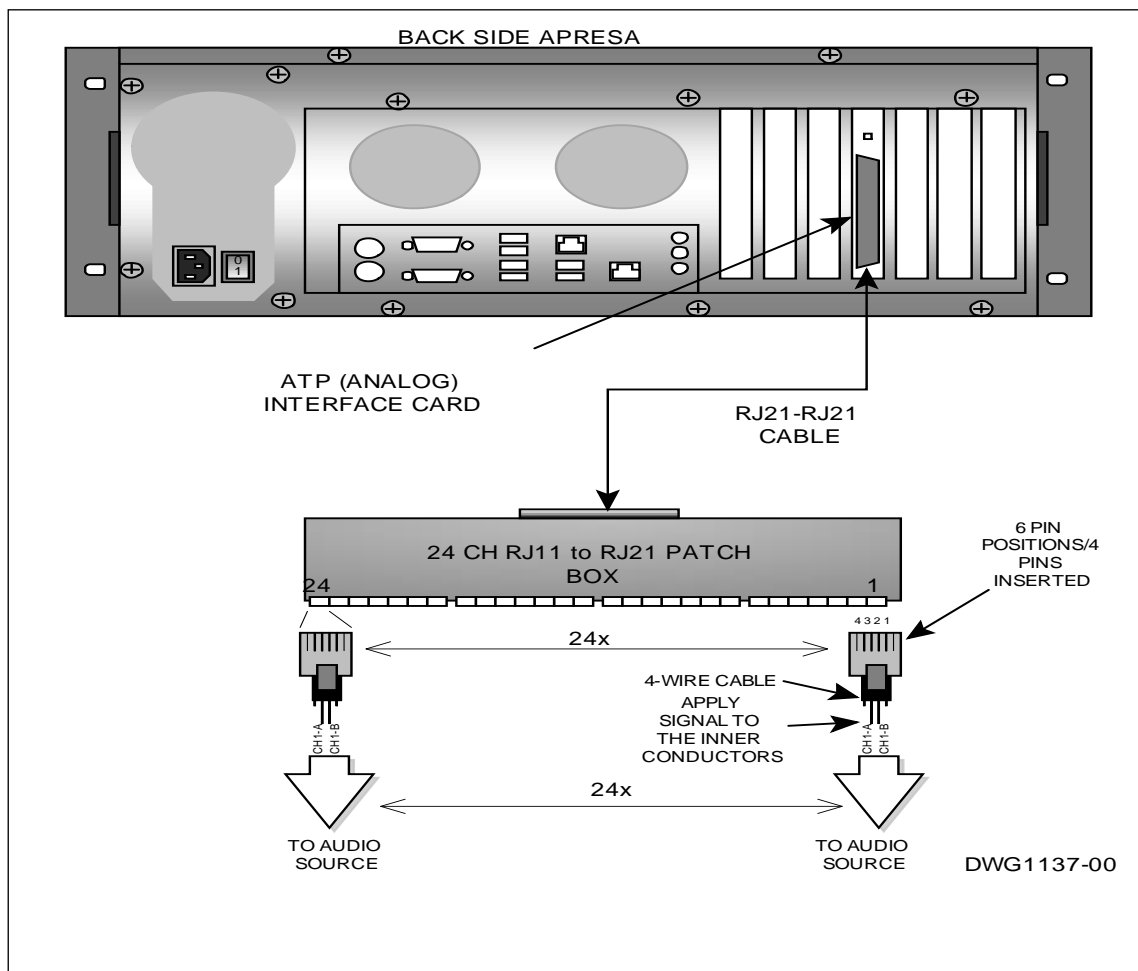

The RJ11 Patch Box supports 24 channels. Each channel on the Patch Box has its own RJ11 inlet connector. Note that the RJ11 modular connector has 6 pin positions of which only 4 are in fact having contacts. RJ11 is also referred as a 6P4C modular connector.

4.4.4. Direct wiring (NOT using a Patch Box)

Following this way of installation, possible with ATP- or DST-cards, the supplied cable will only have one RJ21 connector and an open end. After stripping the outer sleeve of the open cable-end, one will have access to 25 colored twisted pairs. Only 24 twisted pairs represent the recording channels, the 25th twisted pair has no function and can be ignored.



2 DIFFERENT COLORING SCHEMES ARE USED

SIMPLE OHMIC MEASUREMENT BY YOU IS NEEDED TO FIND OUT THE COLORING SCHEME TO FOLLOW

Follow the CORRECT table below to find a particular channel twisted pair.

For instance when locating the wires associated with **channel 9**, look for the colors of **PAIR # 9** in the CORRECT table below, and find the wires (SCHEME #1) identified by a **RED** wire & **BROWN** wire **AND** twisted together.

PAIR #	COLORING #1:	
1	WHITE	BLUE
2	WHITE	ORANGE
3	WHITE	GREEN
4	WHITE	BROWN
5	WHITE	GREY
6	RED	BLUE
7	RED	ORANGE
8	RED	GREEN
9	RED	BROWN
10	RED	GREY
11	BLACK	BLUE
12	BLACK	ORANGE
13	BLACK	GREEN
14	BLACK	BROWN
15	BLACK	GREY
16	YELLOW	BLUE
17	YELLOW	ORANGE
18	YELLOW	GREEN
19	YELLOW	BROWN
20	YELLOW	GREY
21	PURPLE	BLUE
22	PURPLE	ORANGE
23	PURPLE	GREEN
24	PURPLE	BROWN
25*	PURPLE*	GREY*

PAIR#	COLORING #2:	
1	BLACK	GREY
2	BLACK	BROWN
3	BLACK	ORANGE
4	BLACK	GREEN
5	BLACK	BLUE
6	RED	GREY
7	RED	BROWN
8	RED	ORANGE
9	RED	GREEN
10	RED	BLUE
11	YELLOW	GREY
12	YELLOW	BROWN
13	YELLOW	ORANGE
14	YELLOW	GREEN
15	YELLOW	BLUE
16	PURPLE	GREY
17	PURPLE	BROWN
18	PURPLE	ORANGE
19	PURPLE	GREEN
20	PURPLE	BLUE
21	WHITE	GREY
22	WHITE	BROWN
23	WHITE	ORANGE
24	WHITE	GREEN
25*	WHITE*	BLUE*

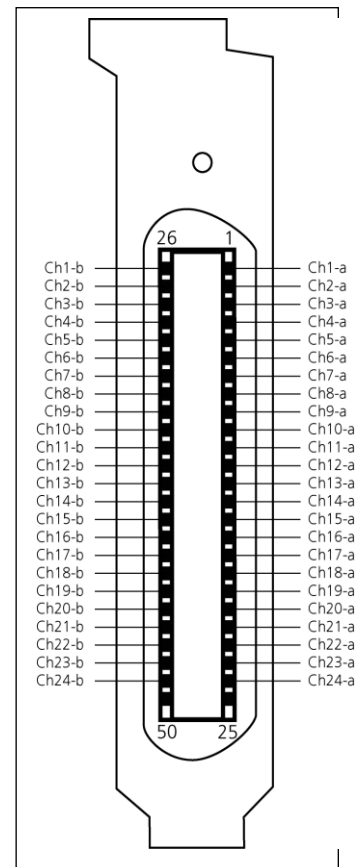

*) = This pair is not used / not connected.

NOTES:

- THIS IS SUPPORTING INFORMATION ONLY AND WE ADVISE YOU TO CAREFULLY CHECK THE CABLE YOU HAVE, AS ITS COLORING SCHEME MAY EVEN BE DIFFERENT FROM THE 2 SCHEMES LISTED ABOVE.
- THE CONNECTOR SHOWN AT THE RIGHT IS THE ONE ON THE INTERFACE CARD (ON THE PC BRACKET) AND THE NUMBERS 1/26 AND 25/50 ARE SWAPPED IN COMPAPRISON WITH THE NUMBERING PRINTED ON THE CONNECTOR BY THE CONNECTOR MANUFACTURER. WE USE THE SWAPPED NUMBERING TO KEEP COMPLIANCE WITH DOCUMENTATION OF THE INTERFACE CARD MANUFACTURER.

4.5. Wiring ANALOG TELEPHONY (POTS) TAPS

GOOD EARTHING OF THE APRESA IS IMPORTANT FOR THE CORRECT OPERATION OF THE ATP ANALOG INTERFACE CARDS. GOOD EARTHING IS MADE BY USING AN EARTHED WALL SOCKET FOR THE MAINS SUPPLY.

The interface card that is used to make POTS taps is the ATP-card. See chapter 13.1 for the specification and the connections of this type of interface card.

Wire taps of POTS-type telecom lines always involves **two** active wires per tapped telephone. For the APRESA the polarity of the signal is irrelevant and can be ignored during wiring. The wiring-type used to install the analog telephone system can very different as we see in the field:

- *Old fashioned twisted pair;*
Normally there are even 2 twisted pairs in the cable. The primary telephone is on the RED/GREEN pair and the secondary telephone (if any) is on the BLACK/YELLOW pair.
- *4 wire modular cable with RJ11 modular plugs (RJ11=6P4C);*
The inner 2 wires carry the signal of the primary telephone, while the outer two are used for the secondary telephone (if any).
- *8 wire modular cable (CAT5) with RJ45 modular plugs and the possible use of (standard) patch panels.*
This cable type is preferred for all new installations because of low cross talk figures. The cable contains 4 twisted pairs. Each twisted pair can connect a telephone. We see 1 or 2 telephones on these cables in the field. Technically however this cable can connect 4 individual telephones.

The installation needed is straight forward as all POTS extensions that must be recorded must be connected (by 2 wires) to an individual recording channel of the ATP interface card of the APRESA.

The analog/POTS wiring taps can be realized in 3 ways:

1. Direct wiring of the RJ21 connector of the interface card (pinning above)
2. With the RJ11 patch box (POTS signal to pins 3&4, NO CONNECTION TO OTHER PINS!
3. With the RJ45 Tapping Patch box.

4.6. Wiring TDM Telephony TAPS

The interface card that is used to make TDM taps is the DST-card. See chapter 13.2 for the specification and the connections of this type of interface card.

Almost all enterprise class PBX systems use proprietary protocols to communicate with the attached telephones.

These telephones are not standard types and can only communicate with the PBX of the same manufacturer.

The wiring of TDM telephone taps is a little complex. The complexity is not the number of wires to connect, but in the non-standardized pinning of the connectors used by the various PBX manufacturers. Another complicating factor is that besides the familiar 2-wire communication some manufactures deploy a 4-wire scheme for communication between the PBX and the telephones.

4.6.1. 2-Wire Vs. 4-Wire

In case of a *2-Wire* connection the communication between telephone and PBX is bi-directional. The PBX use a ping/pong-type protocol for the voice exchange from telephone to PBX and vice versa (=half duplex). With the *4-wire* connection one pair carries voice information from telephone to PBX while the other pair does the same, but from PBX to telephone (=full duplex). Note that there is no separate path for voice and signaling!

The 2-Wire connection uses **one** recording channel on the APRESA while the 4-Wire connection uses **two** recording channels.

This makes the 4-wire connection scheme in terms of channel costs twice as expensive as the 2-Wire variant, but there is nothing practical that you can do about this.

4.6.2. Wiring schemes

The whole issue of wiring TDM telephony TAPS is simply just to identify the wire-pair (or wire pairs) that carry the voice data and to connect these wires to recording channel(s) on the APRESA.

The first step is to find out the name of the manufacturer and the model number of the PBX and Telephones.

The TDM wiring taps can be realized in 3 ways:

1. Direct wiring of the RJ21 connector of the interface card (pinning see above)
2. With the RJ11 patch box
3. With the RJ45 patch box

- TDM with direct wiring on the RJ21 plug

Identify the wire-pair(s) that carries the signal and hook these to the recording channels on the RJ21 plug by soldering or whatever means you prefer. Note that the 4-wire connection must be on adjacent recording channels (f.i. CH1+CH2, NOT CH2+CH3)

- TDM with the RJ11 patch box

Use a RJ45 'T'-splitter and make a custom (DIY) cable to adapt for the various PBX manufacturers.

You need to make a custom cable for every telephone to tap.

The custom cables are built with standard modular cable.

One end has a RJ11 (6P4C) modular jack and the other end has a RJ45 (8P8C) attached. There are different wiring schemes to follow for the various PBX brands.

Always test **ONE** custom cable first to avoid time and material loss.

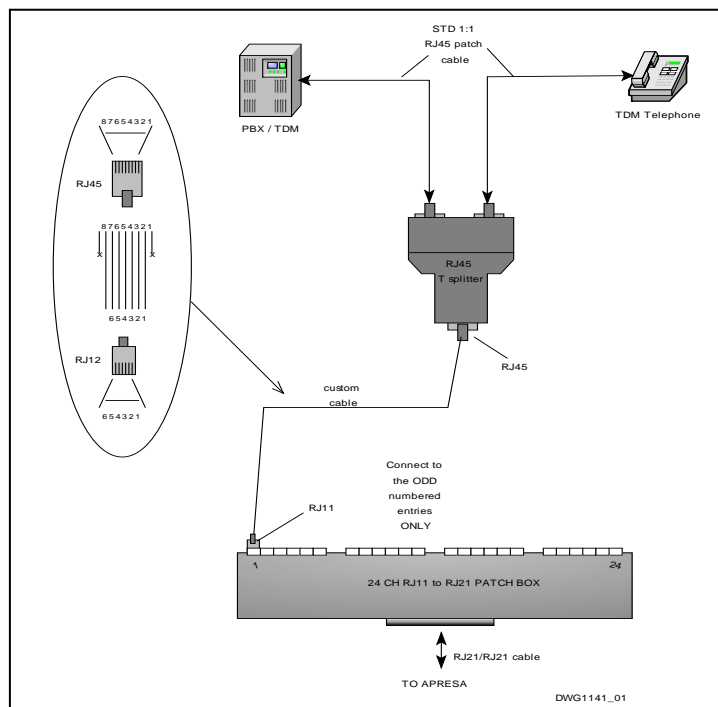

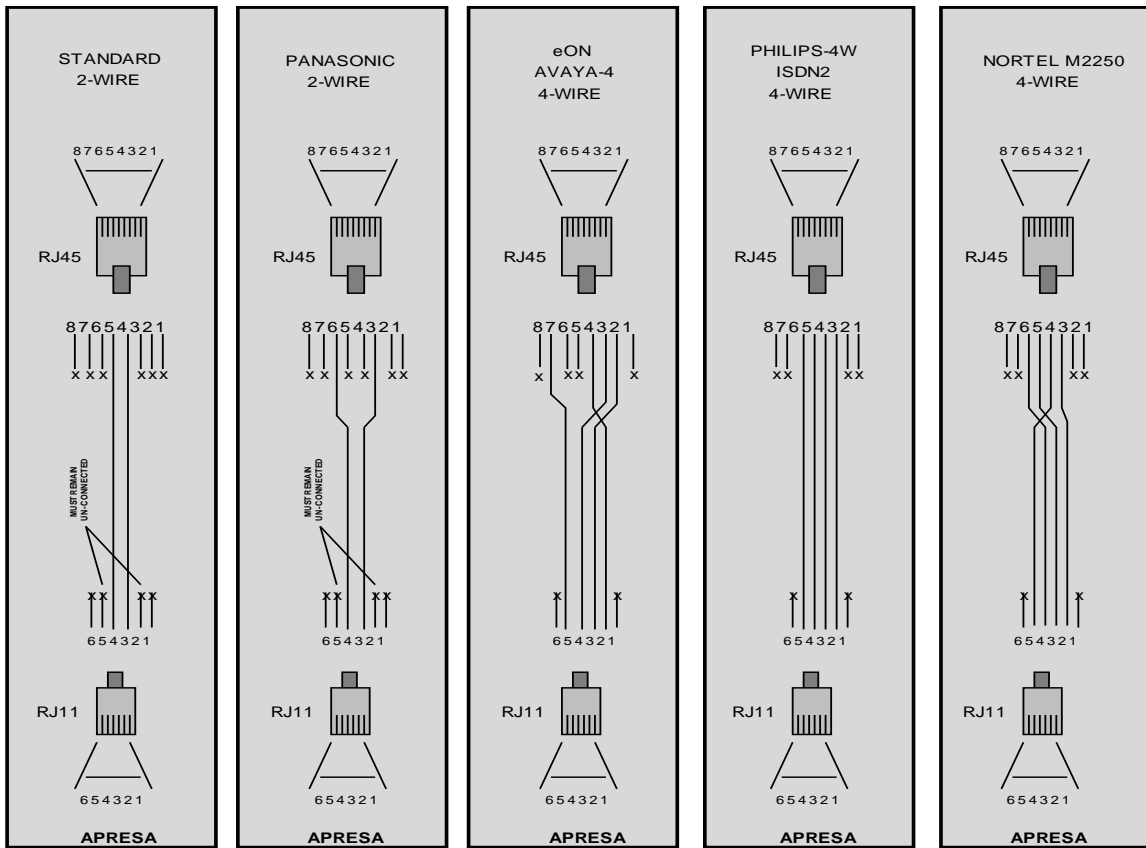

DWG1142_01

IMPORTANT NOTES ON USING THE RJ11 PATCH BOX



WITH 2-WIRE CONNECTION YOU CAN USE ALL 24 OUTLETS OF THE RJ11 PATCH BOX



WITH 4-WIRE CONNECTION YOU CAN ONLY USE THE ODD NUMBERED OUTLETS OF THE RJ11 PATCH BOX

- TDM with the TAPPING PATCH-BOX

The use of the Tapping Patch-box brings you several advantages:

- 19" RACK mountable
- NO 'T'-splitters needed.
- NO custom cables needed.

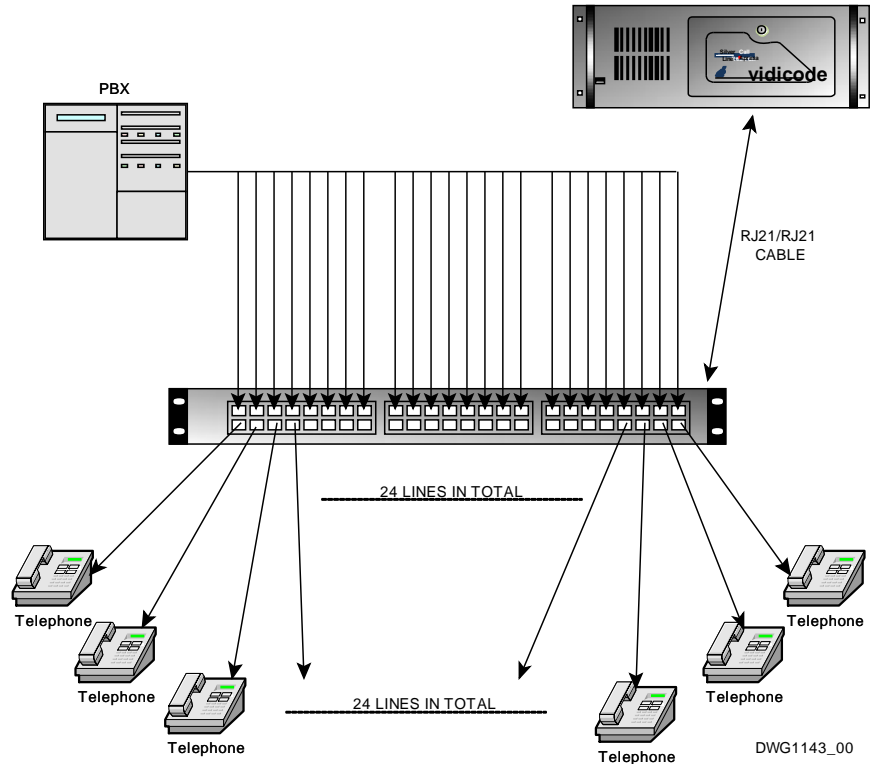

Further information can be found in the chapter that describes the Tapping Patch-box.

4.7. Wiring ISDN2 Telephony TAPS (Basic rate ISDN)

ISDN2 or ISDN-basic rate is from a wiring point of view pretty much identical the 4-wire TDM installation. Refer to the previous chapter.

4.8. Wiring ISDN E1/T1 Telephony TAPS

The interface card that is used to make E1/T1/J1 taps is the DTP-card. See chapter 13.3 for the specification and the connections of this type of interface-card. There are 2 different wiring approaches: the twisted pair type (RJ48C) and the coaxial type. The twisted pair type of wiring is the commonly used wiring type. The diagram below shows the TAP installation. By the RJ45 splitter both receive and the transmit pairs are fed to the DTP card.

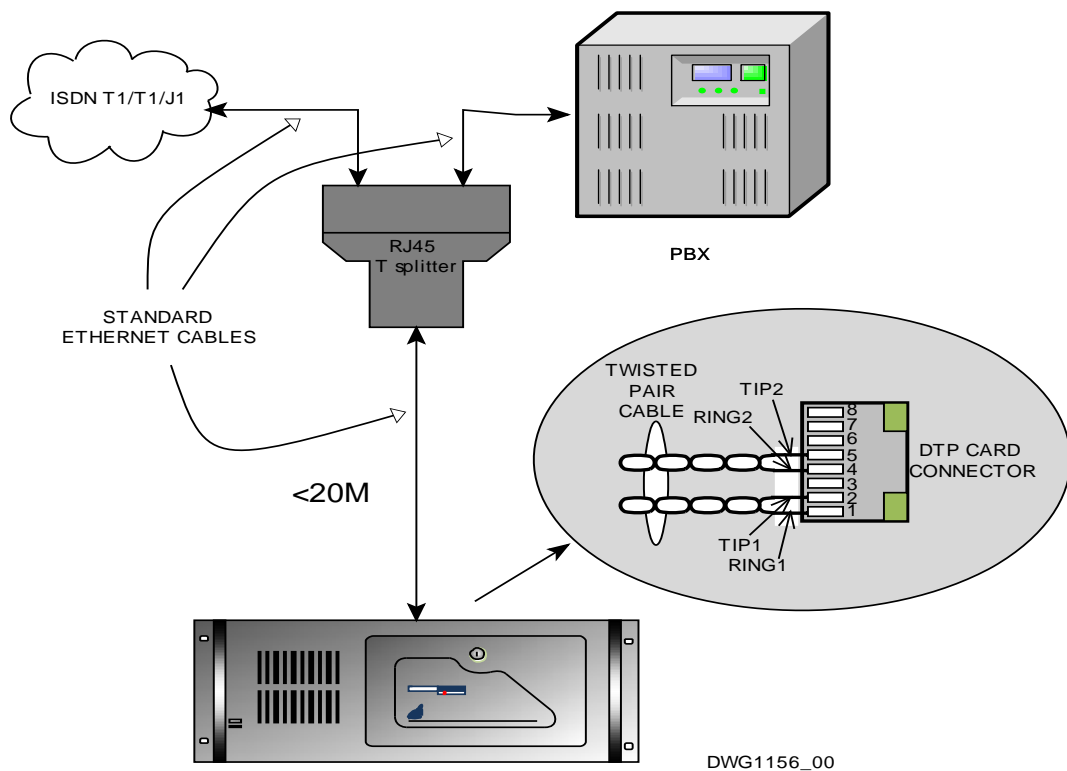

All cables used are twisted pair cables. Refer to the pinning of the DTP connector in the drawing for signal reference. The cable between the RJ45 splitter and the APRESA should be less, then 20 meter in length. This cable should be twisted pair and explicit **NOT** parallel pair cables that are commonly used for ISDN basic rate installations.

It is always a good practice to keep the cable length between the splitter and the APRESA **as short as possible**. It is confirmed that in *optimal* configurations up to 20M will work, but in your situation the signal quality at the splitter may have degraded already by long cabling or distortion. Too much framing errors will occur and the APRESA stops recording this specific trunk. (Restart recording component to recover from this situation)

If you must TAP an ISDN E1/T1/J1 installation that deploys *coaxial* wiring type you must use the diagram below:

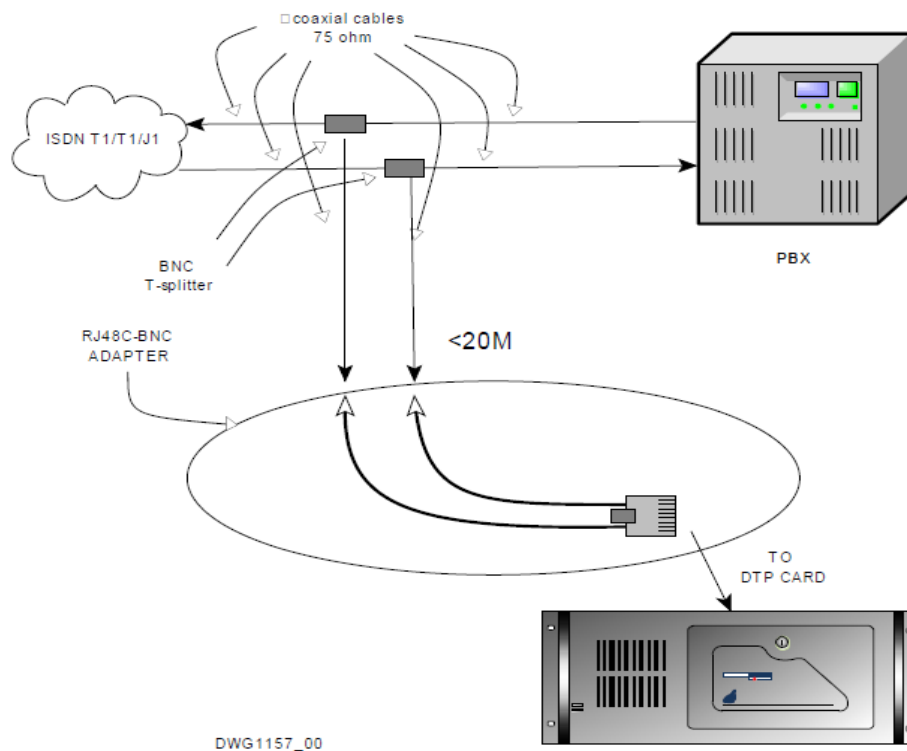

There are in fact 2 coax cables to tap with E1/T1/J1. The actual tap is made by using a “BNC” T-connector, one in each coax cable. The coaxial cables used are of 75-ohm characteristic impedance. The cable between the BNC T-splitter and the APRESA should maximum 20 meter in length.

A Photo of the RJ48C BNC adapter



A photo of a BNC T-Splitter



4.9. Configuration of VOIP telephony recording

In all the telecom networks described so far, the TAP connections are all based on the same principle of “high impedance signal tapping”. With modern telephony based on Ethernet, like VoIP, the actual tapping job is not on the hardware level, but on the TCP/IP packet level. The “packet tapping” is performed by a port-mirroring switch.

Port mirroring functionality is supported by almost all enterprise-class network switches, also called managed switches. On Cisco switches, the port-mirroring functionality is referred as ‘SPAN or RSPAN’.

A VoIP network that requires call recording must always deploy at least one port-mirroring switch. This switch must be configured to copy packets from one or more (source) ports to one (destination) port. The destination port is normally connected to the recorder system and the destination port of the switch actually forms a single or multiple-TAP.

Another important issue to consider regarding the switch selection is the internal bandwidth of this device. This is an issue that requires the assistance of the network manager at the customer premises, especially with topologies where data and VoIP are sharing the Ethernet. The switch that we supply has an internal bandwidth of 32 Gbps.

With VoIP telephony, all information is sent over the network by (RTP / SIP etc.) packets. The basic issue of the whole configuration job of VoIP telephony recording is to setup the network components in such a way that the APRESA ‘see’ these RTP packets on its recording NIC (NIC, Network Interface Card).

Apresa uses RTP data to record the audio of VoIP calls. The VoIP PBX should be configured to use only G.711, G.722, G.729, GSM 6.10, or iLBC. These Codecs are supported in Apresa. Apresa will not record audio in other Codecs. Some VoIP telephones can also be configured for Codecs.

For every APRESA recording channel that uses the G.729 codec the G.729 license is free of charge and included in the channel license.

It is also required by the APRESA that the encryption on the VoIP PBX is switched off.

Depending on the customers recording requirements we distinguish 2 fundamental different solutions 1) *Trunk Side Recording* and 2) *Station Side Recording*

4.9.1. Trunk Side Recording

This method will generally record inbound and outbound calls.

Often, with trunk side recording, the specific extension number of the person who answered the call is not visible and only the general company number is displayed. Also, it is possible that the extension number of the person who answered the call is displayed correct, but when the call is transferred, the extension number of the co-worker is not displayed. Using

trunk-side-recording suffer these drawbacks. Finally, internal (or local) calls are **NOT** recorded at all at the trunk side of the telephone system.

With trunk side recording, only one port-mirroring switch is needed to facilitate a single tap on the VoIP PBX. The simple switches (without port-mirroring) that may be used in the existing VoIP network need not to be replaced.

4.9.2. Station Side Recording

This method will record the calls from all phones on the network (inbound-, outbound- and local-calls). If the RTP packets between the internal phones run via the PBX and the switches in the existing VoIP network have no port-mirroring facilities, they must be replaced.

There are VoIP implementations where VoIP data is traveling together with other network data over the companies Ethernet and we see separate Ethernet networks for VoIP. When VoIP is traveling together with the regular network data on the same network, the VoIP packets (=real time!) must have priority over the normal network packets. This is achieved by setting the QoS (quality of service) in favor of the VoIP packets. So far this is standard configuration practice for VoIP telephony. A switch overruns when the maximum supported internal bandwidth is exceeded. A network switch that operates close to his bandwidth limit may fail in his port-mirroring function especially in situations where there are many source ports to mirror. This is one of the reasons of the very wide pricing range of network switches we see in the market. Choose the network switch wisely, because VoIP recording totally rely on the port-mirroring function of the switch you select.

Another important consideration in the decision for trunk-side or station-side recording is the issue of difference in protocol and the use of encryption. Always, first check the compatibility of Apresa.

Obviously, the installer of a VoIP recorder has to work closely together with the clients network manager as this manual cannot cover all topics relevant to VoIP environment and installation.

The next section presents several VOIP topology examples. All examples are based on enabling the APRESA to 'see' the data to be recorded. To find the valid example that applies to your VoIP-situation, just get the answer to the 3 questions below:

- Find out the Network type
- Find out the routing of the RTP packets
- Find out: record ALL calls or only in & out bound calls.

The flowchart below will lead you to the applicable diagram.

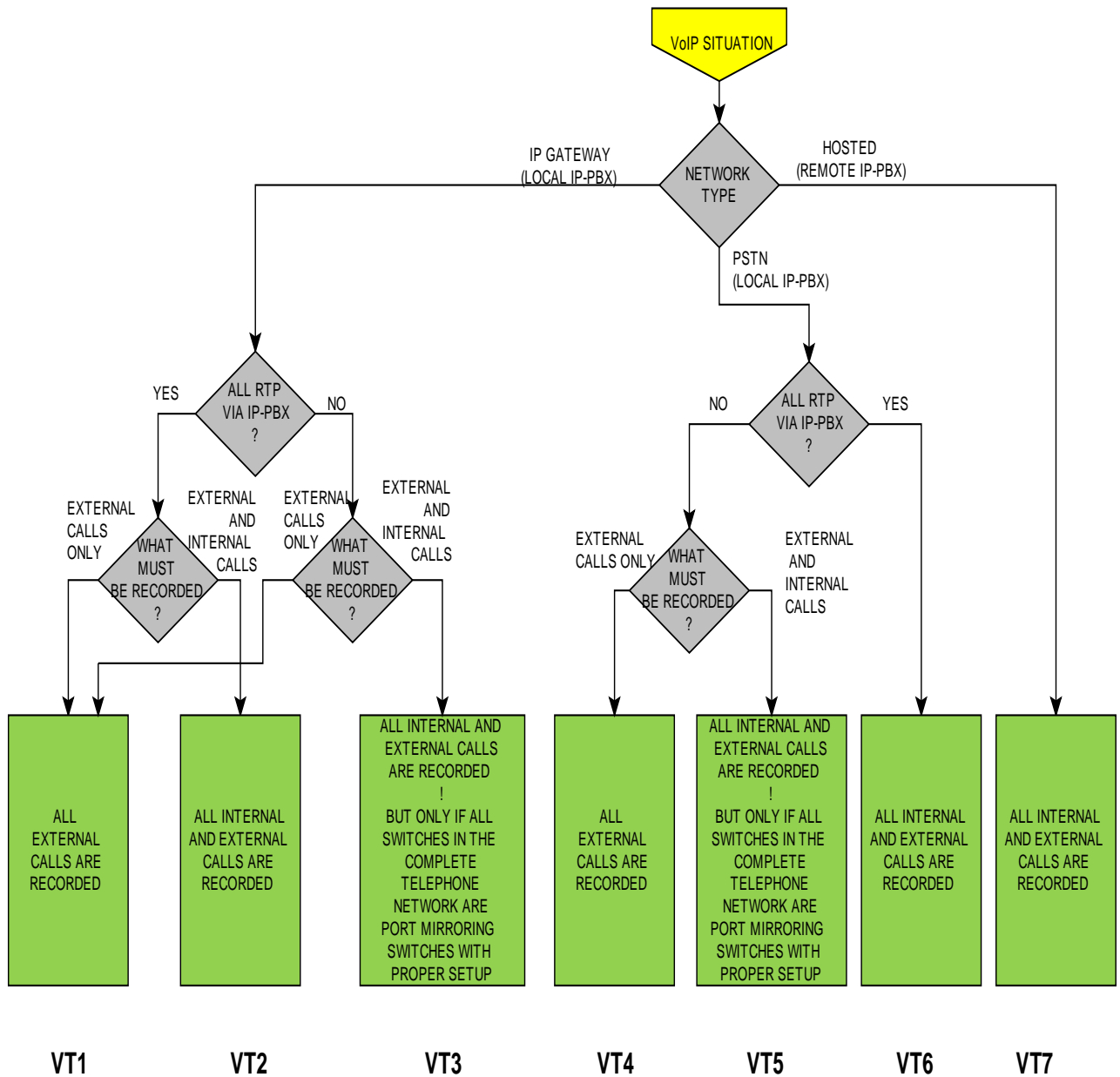

DWG1155_01

VT1 VT7 on the bottom refers to on of the 7 diagrams that follow below:
 (for compact drawing a 5-port switch is used)

4.9.3. VoIP topology 1

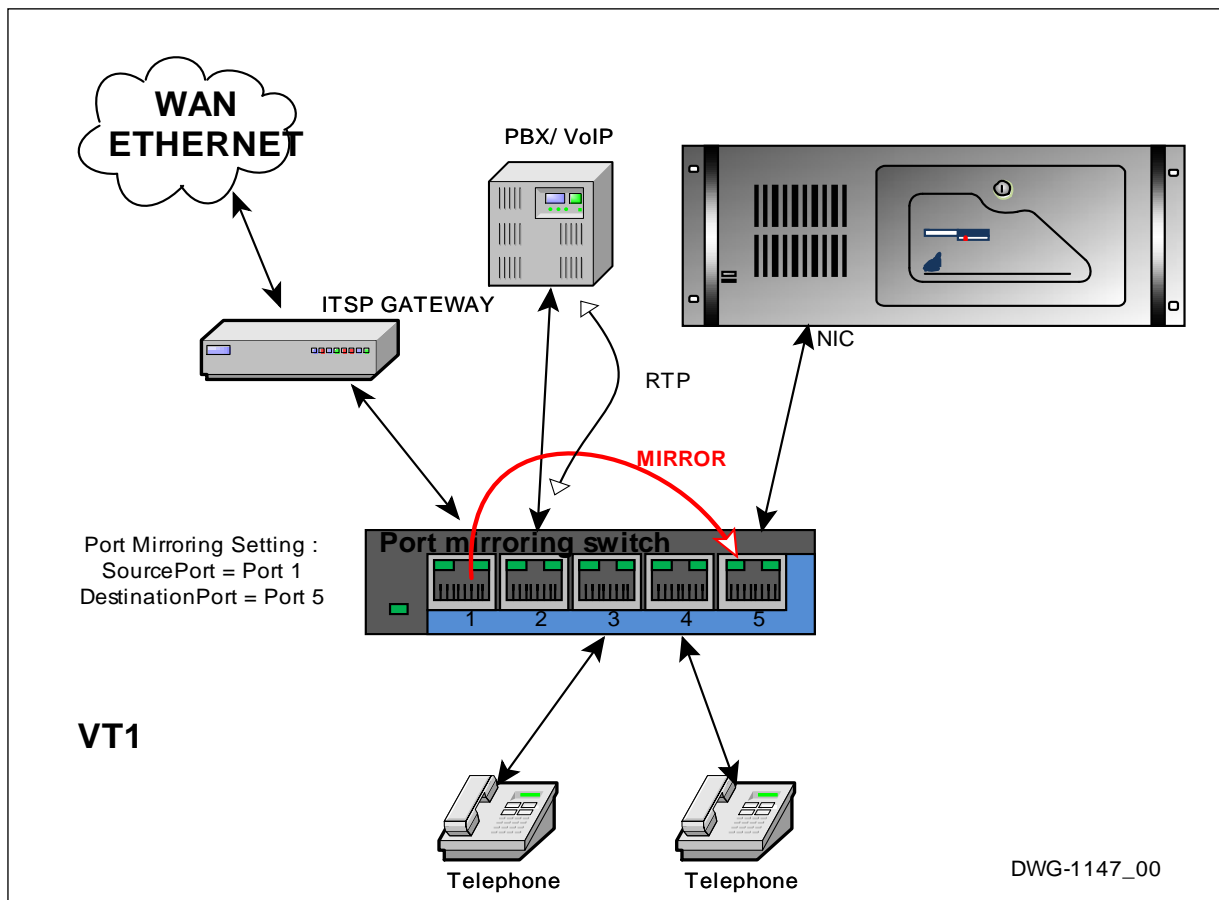

ONLY EXTERNAL CALLS ARE RECORDED

4.9.4. VoIP topology 2

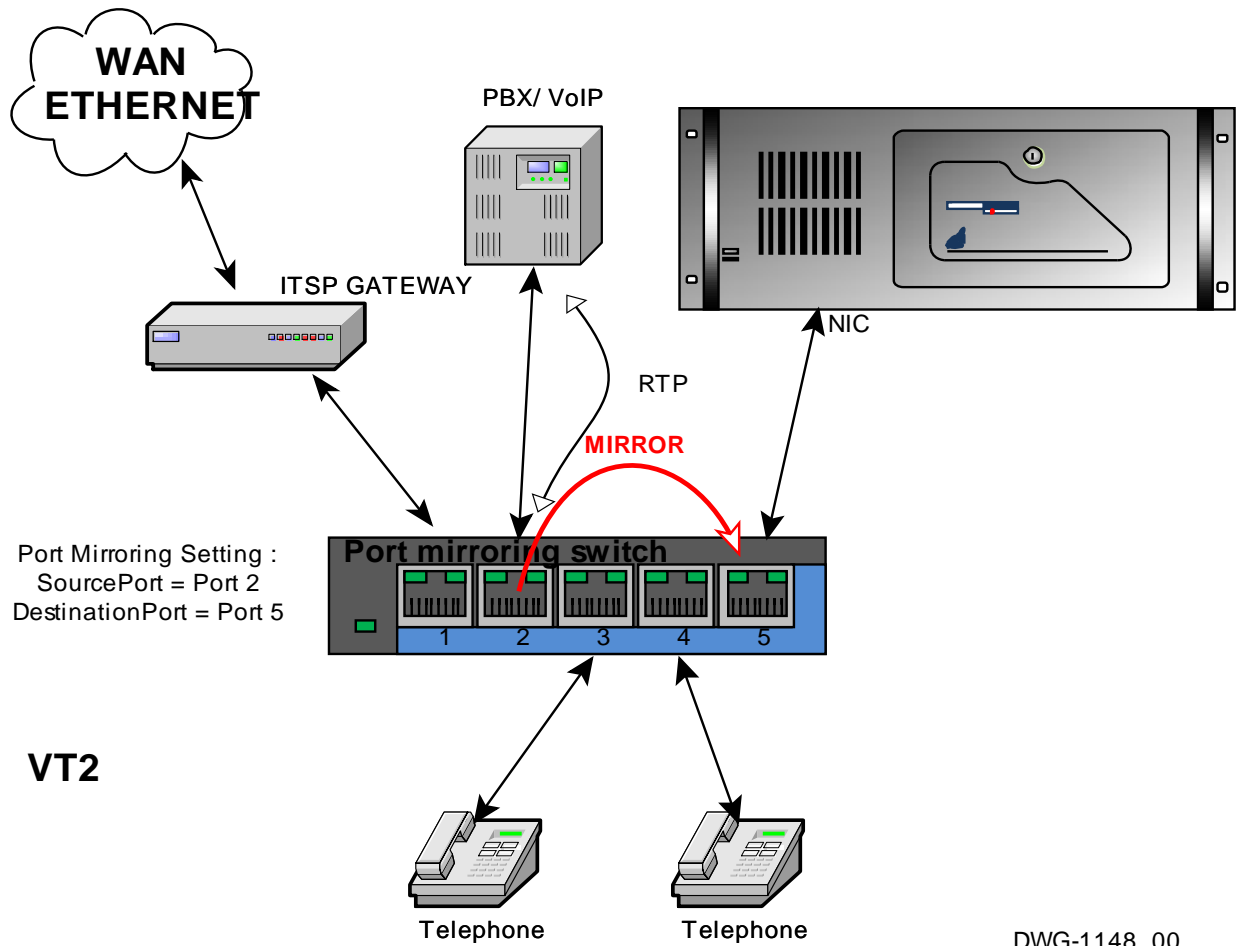

DWG-1148_00

INTERNAL AND EXTERNAL CALLS ARE RECORDED

4.9.5. VoIP topology 3

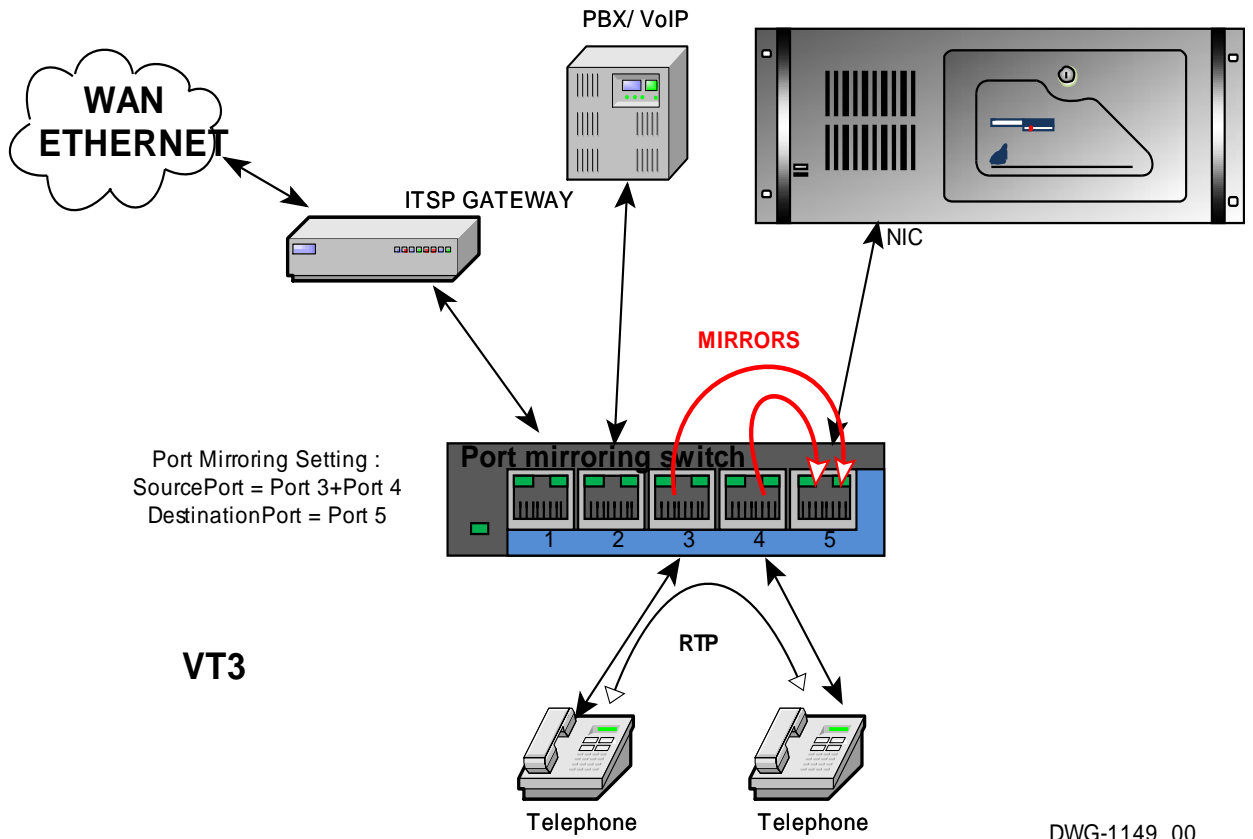

DWG-1149_00

INTERNAL AND EXTERNAL CALLS ARE RECORDED

4.9.6. VoIP topology 4

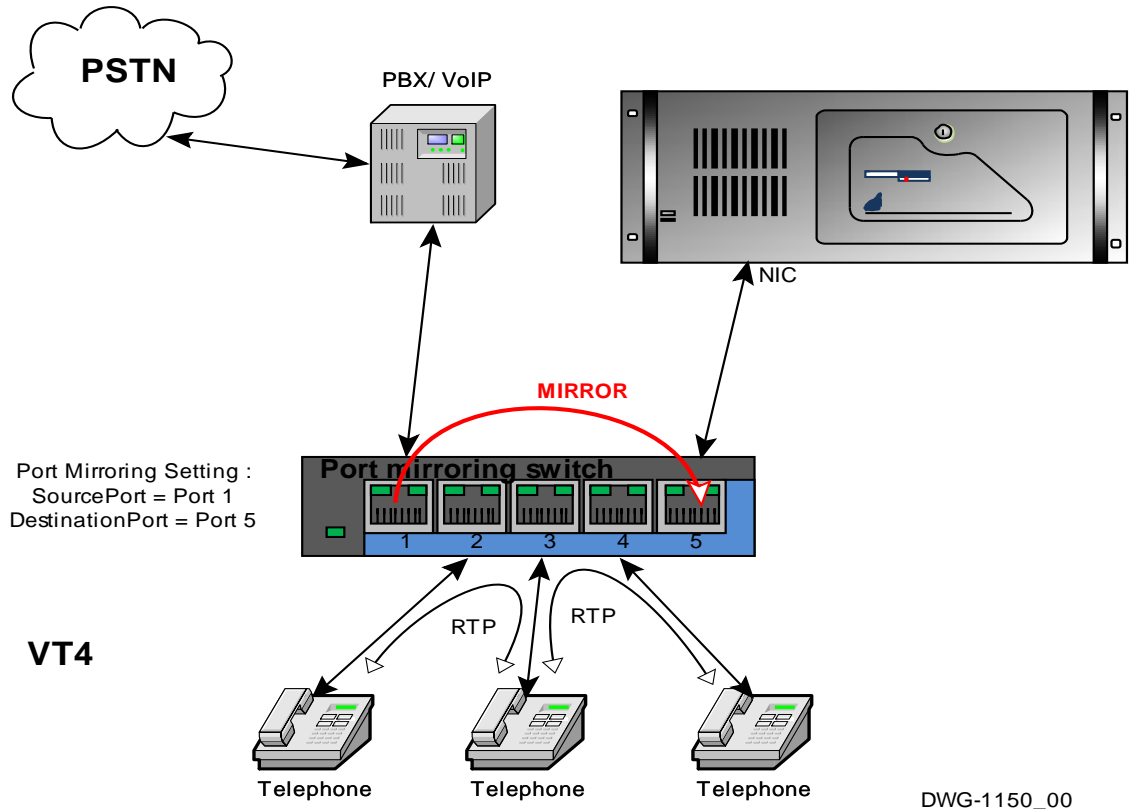

ONLY EXTERNAL CALLS ARE RECORDED

4.9.7. VoIP topology 5

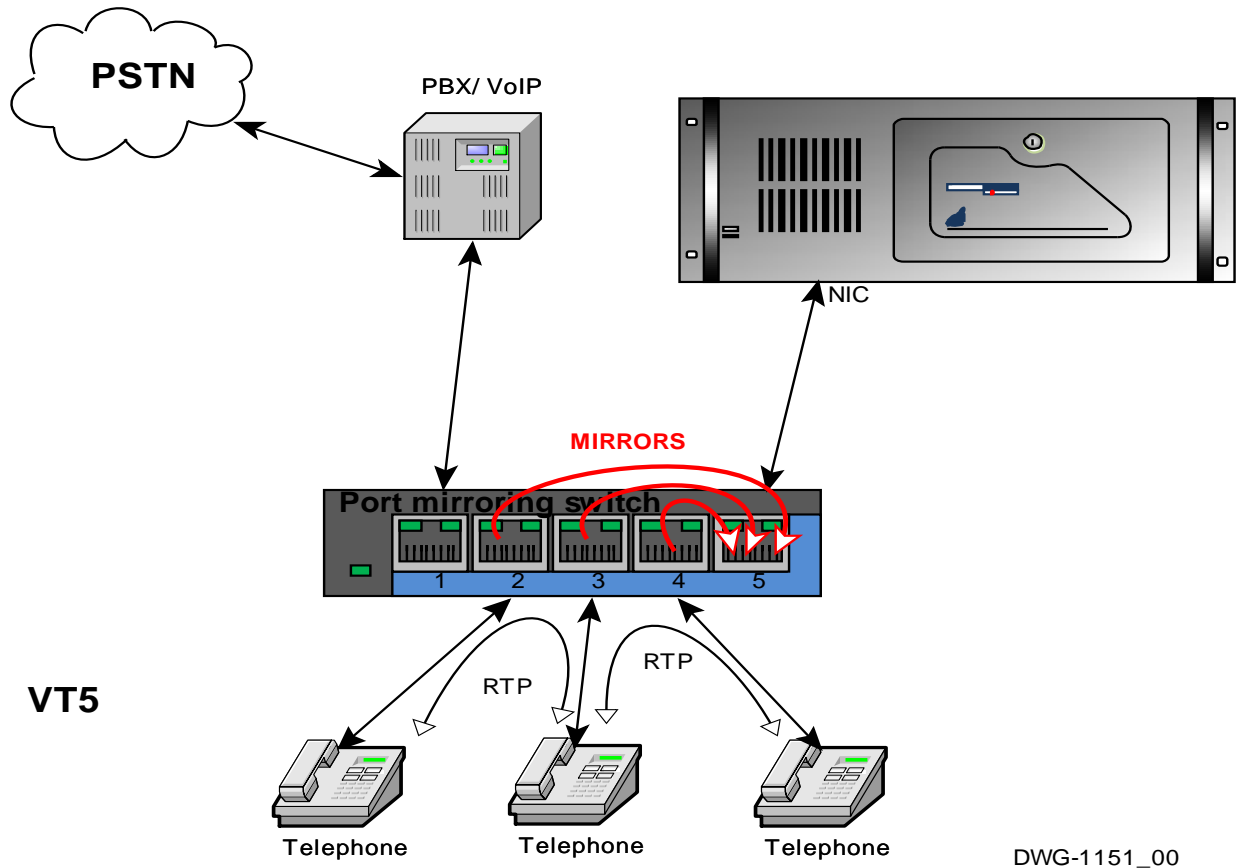

DWG-1151_00

INTERNAL AND EXTERNAL CALLS ARE RECORDED

4.9.8. VoIP topology 6

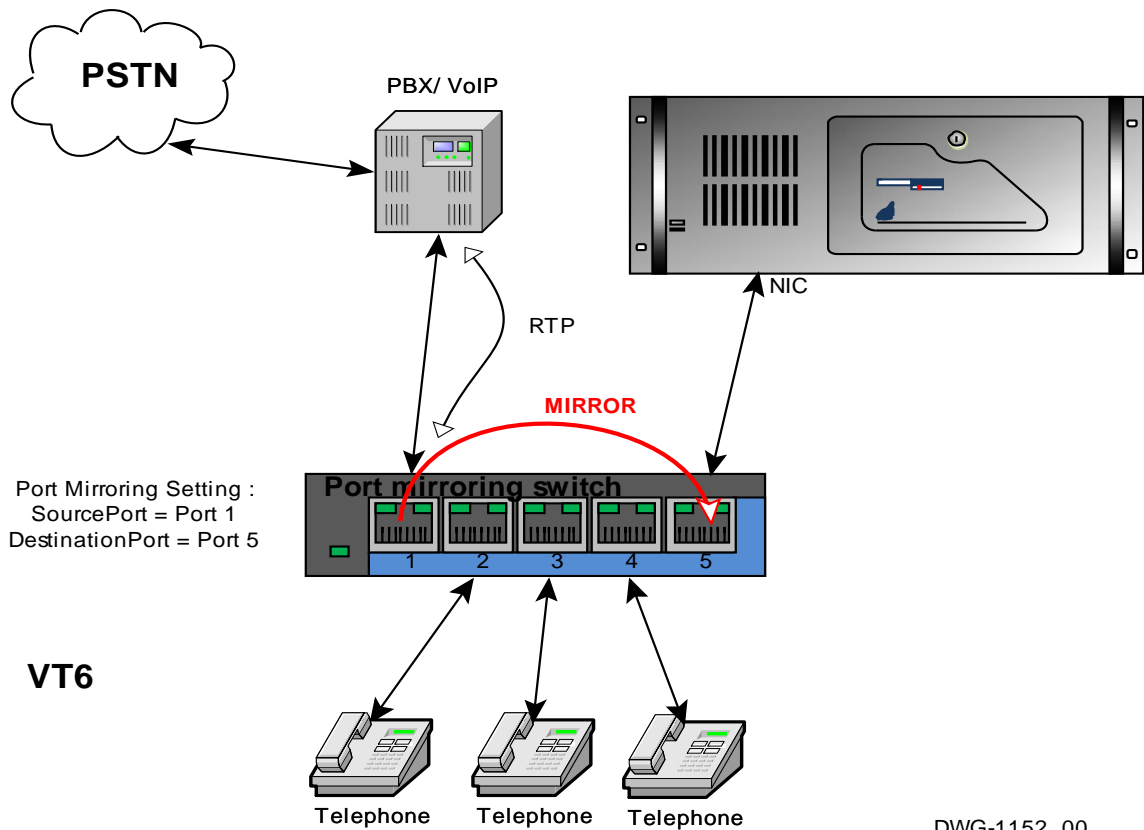

DWG-1152_00

INTERNAL AND EXTERNAL CALLS ARE RECORDED

4.9.9. VoIP topology 7

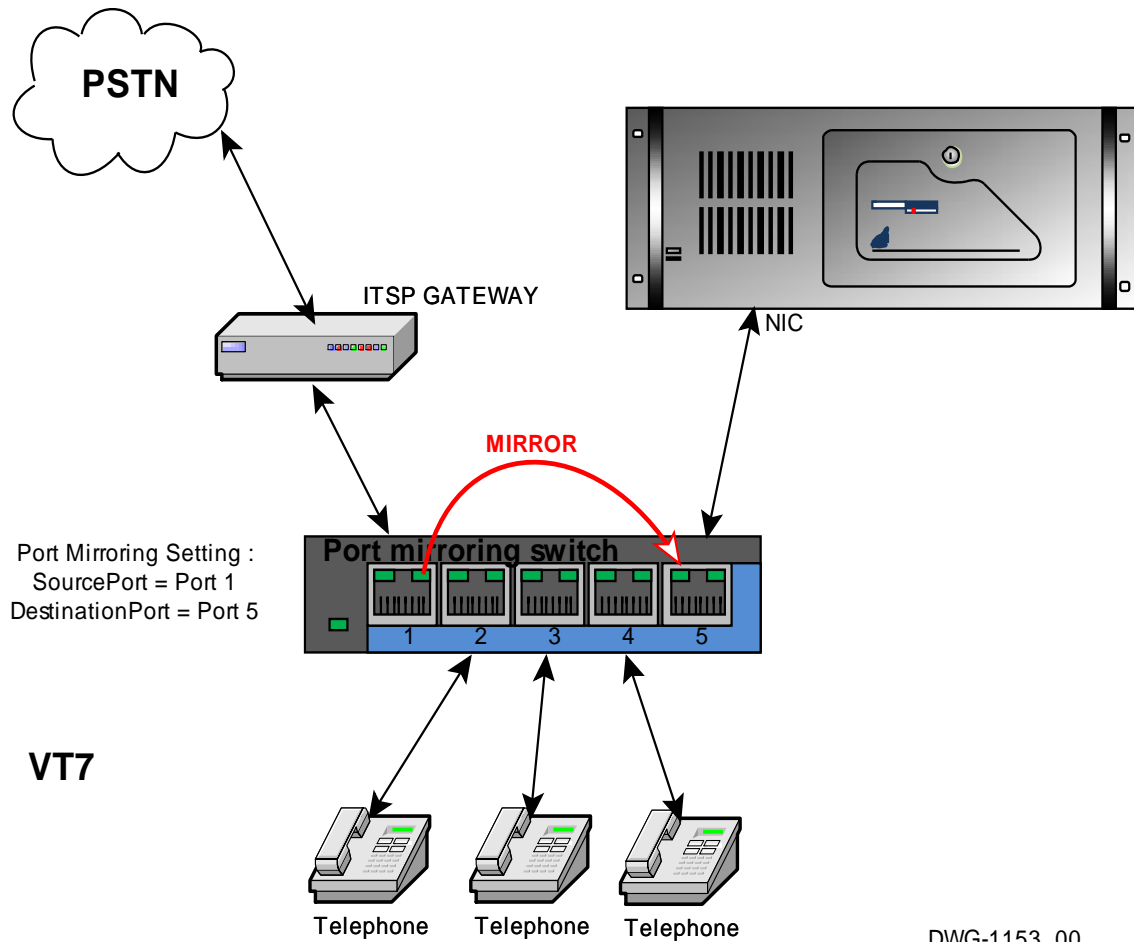

INTERNAL AND EXTERNAL CALLS ARE RECORDED

4.10. Configuration of TETRA communication recording

NOT YET SUPPORTED

4.11. Patch panels

Patch panels are used to ease the telecom wiring.

For VoIP, TETRA installation the standard Ethernet patch panels are applicable. Also, for connection to the DTP (ISDN-E1 / ISDN T1) the standard Ethernet patch panels are applicable, but you need a RJ45 "T" splitter for every trunk to tap.

For connection to the ATP and the DST cards (AUDIO/POTS/TDM/ISDN2) we offer 2 different patch panels,

- The RJ11 patch panel;
- The Tapping Patch box.

These patch panels use RJ-type connectors. Find everything in detail for RJ cables in Wikipedia.

The RJ11 patch panel is included for every purchased ATP or DST interface card and it is suitable for the smaller installations, up to 8 – 24 channels. This type of patch panel may need special made cabling and external RJ12 "T"- splitters

The Tapping Patch box is optionally available and works with standard Ethernet cables and has a build-in "T" splitter. This is the smoothest way to install obviously.

Patch panels have powerless operation.

4.11.1. RJ11 Patch panel

This type of patch panel is in the standard scope of delivery. For every ATP- and DST- interface card one RJ11 patch panel is standard supplied.



This type of patch panel is capable of interfacing POTS, TDM-2-wire and TDM-4-wire telephone systems. More, the unit is applicable for connecting line level (>400mV) audio sources.

Due to the compatibility with both 2- and 4-wire systems please note the important remarks when installing this unit:

- **WITH POTS (Analog) ONLY CONNECT RJ11 PINS 3&4, the center pins.**
- **WITH 4-WIRE TDM ONLY USE THE ODD NUMBERED PORTS (1,3,5...23)**
- **Seen on the front side channel #1 is on the outer right position.**

The unit is not suitable for 19" rack mounting. Note that this wiring solution may need external 'T' splitter (RJ12 or RJ45) and custom cabling between the splitter and this patch panel.

4.11.2. The Tapping Patch box

Purpose:

The tapping of signal cables in digital (TDM) telephone systems to feed the voice data simple and reliable to the APRESA.

The APRESA is compatible with all major brands (Siemens, Philips, etcetera) in the field of digital PBX.

The APRESA TDM patch panel supports the passive tapping of up to 24 telephones lines.

Telephone line inputs are numbered 1,2,3...24 on the front of the patch panel. Each numbered telephone line input consists of a set of 2 RJ45-type connectors, 1:1 wired for all 8 pins, effectively eliminating the need for external "T"-splitters.

Every telephone line that needs recording must be routed over the Tapping Patch Box. This means that the telephone line coming from the PBX must be plugged in the patch panel and that the other outlet for that channel must connect the telephone. When this is done, all connected telephones should be able to make calls as the tapping is fully passive.

The building wiring in modern offices for TDM telephony is just like the Ethernet wiring. This wiring scheme is very well standardized, all connectors are RJ45 (=8-pin) and carry 4 balanced signal pairs on PIN1/2, PIN3/6, PIN4/5 and PIN7/8.

When the telephone system uses 2-wire connection to the extensions, this means that it will use *one* balanced pair (=2-wires) to establish the link with the PBX. Used pair is on the PIN4/5 and this is the pair has the passive TAP to feed the APRESA recording channels. The remaining 3 balanced pairs (3x2-wires) are of no concern for the data communication (and for the APRESA).

There is only *one* RJ21:RJ21 cable between the Patch Box and the APRESA.

When the telephone system uses 4-wire connection to the extensions, (like Basic rate ISDN) this means that it will use *two* balanced pairs (=2x2-wires) to establish the link with the PBX. Used pairs are on the PIN4/5 & PIN3/6 and these are the pairs having the passive TAPS to feed the APRESA recording channels. The remaining 2 balanced pairs (2x2-wires) are of no concern for the data communication (and for the APRESA).

There are up to *two* RJ21:RJ21 cables between the Patch Box and the APRESA. Per telephone one need 2 APRESA recording channels.

> NOTE THAT THERE ARE 2 DIFFERENT RJ45 PATCH PANELS <
2-WIRE SYSTEM and 4-WIRE SYSTEM
ORDER THE CORRECT TYPE FOR YOUR INSTALLATION

A wiring diagram can be found in the chapter “Wiring TDM Telephony TAPS”.

5. EXPANDING APRESA

> Before changing a commissioned APRESA installation <
MAKE A BACKUP OF ALL RECORDINGS AND SETTINGS
Refer to chapter 7

Expanding an APRESA system means:

- Adding recording channels;
- Increasing the storage capacity;
- Building or changing a RAID volume.

5.1. *How to add recording channels*

The first thing that you need to know is that adding recording channels takes a 2-step approach:

- Adding hardware interface card(s) or interface module(s).
- Activating recording channel licenses;

5.1.1. **Channel license upgrade**

For every recording channel expansion, you must handle as follows:

- Buy channel license(s) from your dealer or from directly VIDICODE;
- Link the license to your machine (www.vidicode.com/channels);
- Enter the response license code in your machine.

Refer to chapter 3 for more details.

5.1.2. Installation of interface cards

If you are expanding the number of VoIP or TETRA channels in your system you never need extra interface cards, just skip this section and go to the telecom wiring chapter.

Upgrading VoIP channels or TETRA channels never requires extra interface cards to be installed because VoIP telephony and TETRA runs over Ethernet.

For AUDIO / POTS / TDM / ISDN2 / ISDN E1/T1

The interface cards that are already present in your machine may have unused channels left that can be used now. If there are a sufficient number of channels spare, just skip this section and go to the telecom wiring chapter.

You need to know that the ATP-interface card and the DST-interface card can support 8-, 16- or 24 channels. Basically, these cards are 8 channel cards that can hold up to 2 optional 8 channel interface modules. Adding hardware channels *may* only involve adding 8-channel interface modules in situations where a vacant expansion module position is available on the right type of interface card.

For the hardware installation of interface cards refer to chapter 4

5.1.3. Installation of interface modules

(This section applies only to ATP- and DST interface Cards)

The ATP- and the DST interface cards have 24 channels but may in fact be populated with only 16 or even only 8 channels installed. Channel upgrades are possible by the installation of 8 channel interface modules on the base card:

Base card only	= 8 channels.
Base card +1 interface module	= 16 channels.
Base card +2 interface module	= 24 channels.

NOTE: ATP and DST expansion modules are NOT identical

Use MOD_24A on ATP Cards and use MOD_24DB on DST Cards

The installation handling for mounting the upgrade card involves the following steps:

1. Remove the interface card that will accept the expansion module, and put it on the table with the PCI (PCIe) connector faced down;
2. The insert location on the interface card for the expansion is listed in the position table below;
3. Note the white text “↑↑UP” on the expansion module.
4. Attach the interface module on to the interface card by checking the correct alignment of all the pins of both connectors involved. Handle CAREFULLY because the connector pins are NOT very tolerant when being bend.
5. Use the 2 screws supplied for final mechanical fixation.
6. Place the interface card back into the PCI (PCIe) slot.
7. No jumpers to set. No reprogramming. Just configure and wire the newly available channels.

INTERFACE CARD PART NUMBER	CH1-CH8	MODULE LOCATION CH9- CH16	MODULE LOCATION CH17-CH24
ATP-24A/PCI+	ON BASE BOARD	B	A
ATP-24A/PCIe+	ON BASE BOARD	B	A
ATP-24A/PCI+(2.0)	ON BASE BOARD	<u>A</u>	<u>B</u>
ATP-24A/PCIe+(2.0)	ON BASE BOARD	B	A
ATP-24A/PCIe+(3.0)	ON BASE BOARD	B	A
DST-24B/PCI+	ON BASE BOARD	B	A
DST-24B/PCIe+(2.0)	ON BASE BOARD	B	A

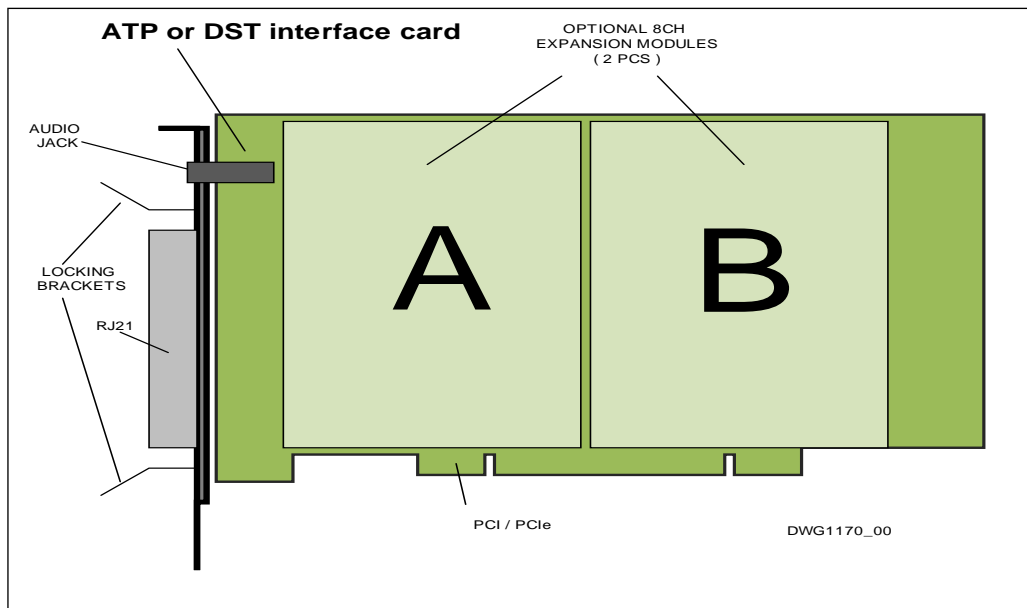

5.1.4. Increasing the storage capacity

Increase of storage capacity is possible by installing a larger hard drive(s). Backup the APRESA and bring it up on the newly installed larger drive(s).

5.1.5. Building or changing a software RAID volume

Changing from NoRAID to RAID1 or vice versa require:

- Backup all your recordings;
- Re-installation of the software in the desired required software NoRAID or RAID configuration;
- Re-installation the channel licenses;
- Restore the recordings;
- Note that you can re-use the original base software- and channel licenses for this machine.

6. BACKUP AND RESTORE BACKUP

Systems can fail for many reasons. Therefore, most APRESA customers demand a reliable and periodic backup of all recordings and system settings stored over time. Network based backup & restore is a standard feature of the APRESA.

For backup click on the WEB interface: **Tools -> System -> Backup**

Specify the network location to store the backup data, the start and end date (backup period) etcetera. and enable backup.

For restore backup click on the WEB interface: **Tools -> System -> Restore backup**

See the ADMIN manual or the online help pages for more information.



REPLACEMENT OF HARDWARE MAY HAVE LICENSING ISSUES

The APRESA software is protected against illegal copying. This protection is based on the linkage of the software license and the hardware signature of the system that was used at first installation.

In case of failing hardware you must (obviously) locate and replace the failing hardware parts.

- Replacing the power supply(s) never involves software re-installation or licensing issues.
- Replacing the hard drive involves new software installation & licensing. Simply re-use the base software license you have. Then perform a restore backup operation to restore all settings and recordings on the APRESA. No licensing issues will occur.
- Replacing the motherboard **WILL** cause a licensing issue. Because the APRESA software license is based on the hardware signature of several unique properties that are located on the motherboard APRESA will detect a licensing issue. On the WEB (home) page this issue will be displayed as shown below:

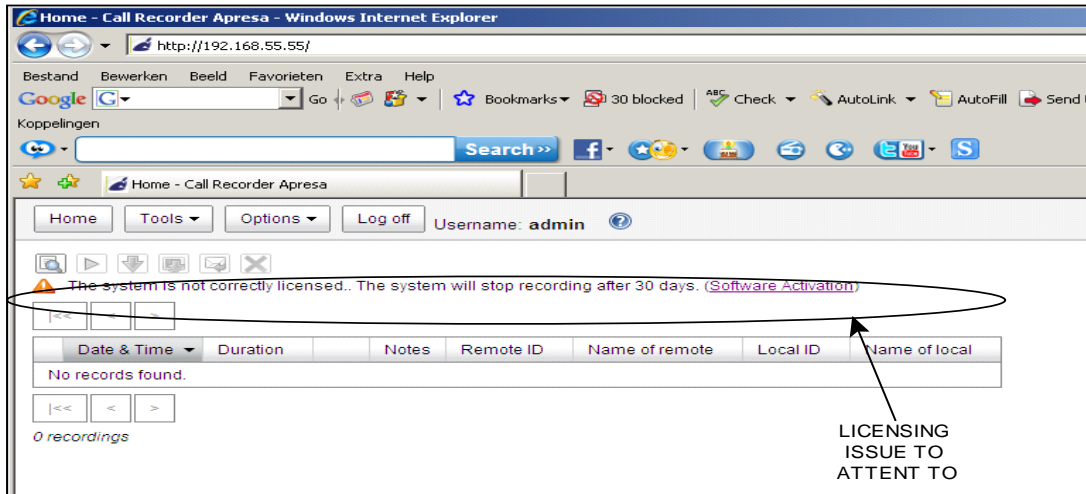

DWG1167_00

Contact VIDICODE sales to obtain a valid license. Note that APRESA with an invalid license will record only for a period of 30 days after installation.

7. MAINTENANCE

7.1. *Hardware*

The Apresa server hardware requires no special maintenance. Nothing worth mentioning here.

7.2. *Software*

Vidicode advises customers to check for Apresa base software updates from time to time as the software is intensively maintained and expanded.

Note that Apresa base software updates are free of charge for every Apresa machine but only with a valid support and Upgrade (S&U) License that must be purchased every 1-or 3 year(s) .

**We strongly advise you to keep your Apresa
Support & Upgrade License valid**

8. REDUNDANT POWER SUPPLY

Redundant power supply is available as standard on the SuperMicro servers:

Vidicode article number. 010.04605 (SuperMicro 1U)

Vidicode article number. 010.04606 (SuperMicro 4U)

For the documentation on the redundant power supply of these SuperMicro servers the user is advised to read the applicable documents on the SuperMicro web-site (www.supermicro.com).

The redundant power supply unit (RPSU) is located at the backside of the housing. The figure below points the items of interest. (your model RPSU may be different in detail due to different models housing used):

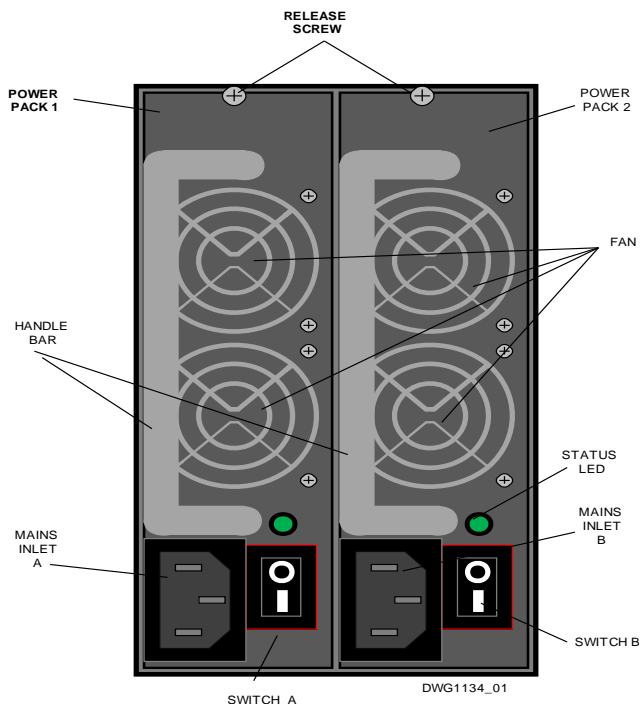

The RPSU is built with 2 removable power packs to obtain 1+1 redundancy. In normal situations both power packs supply the power together based on a load balance mechanism. In the status page of the APRESA (Tools/System/System Information) the health of the RPSU is displayed.

In the event that one power pack fail, the other power pack will take over completely by delivering the desired power standing alone. The APRESA system:

1. Sends a warning E-mail to a configurable administrator/manager client;
(note: **ONLY** when configured properly)

2. The health indicator on the system information page will display this error;
3. SNMP will be supported soon.

A failing power pack must be replaced because the actual redundancy function is lost. Note that the remaining power pack is capable to cover the power needs of the APRESA system completely without any time-limits allowing the replacement to be planned at convenience. There is no need to bring the APRESA system down to swap a power pack as the power packs are 'Hot Swappable'.

It is easy to replace a failing power pack.

1. First step is to locate the failing power pack.
The failing one is identified by an off (not burning) green LED on the power pack housing. This LED is on when a power pack is functioning fine so the one with the LED off is the failing one that must be replaced.
2. Remove the mains power cord from the failing power pack and then use the pull-out handle bar and release the locking (or screw) slide to take the failing power pack out. Note that the failing power pack may have a hot surface, so please be care full.
3. Insert (and mechanically lock) the new power pack and turn the power switch (not on all models) of this unit to 'O'(=OFF). Then insert the mains power cord into the newly installed power pack. Turn the power switch (not on all models) of the new power pack to 'I '(=ON). The green LED should turn on and the whole RPSU is in restored to the safe redundant state.

Tip:

To take the full advantage of the RPSU, connect the 2 mains power cables to different fused mains power groups. By doing this the APRESA system remains stable and powered when a fuse is blown in the building and one power group is going down.

9. STORAGE OPTIONS

The APRESA software can handle various hard drive configurations including RAID.

Because the MTBF figure of a modern, server class, hard drive is well over 1million hour, very reliable and fast systems can be built at relative low cost even without RAID. In a demanding environment, the use of a RAID configuration may be considered to achieve higher write performance.

The hardware RAID is more expensive but is considered to be superior compared to software RAID in terms of system availability, speed and service.

Using RAID improves the system reliability. We advise to use '24x7-grade' hard drives and to build RAID volume with *identical* hard drives.

9.1. Configuration



- No Raid (also referred as 'Standard')
- Software RAID1
- Software RAID5 (deprecated)
- Hardware RAID1
- Hardware RAID5 (deprecated)
- Hardware RAID10

No raid

This is the very basic configuration and it works with only ONE hard drive and when it fails it will cause the system to crash.

Software RAID1

A RAID 1 array deploys always TWO hard drives. This mechanism is also known as the 'Mirroring RAID' because the hard drives are continuously kept to their mutual image. One failing hard drive will have no effect on the system functionality. The capacity of a RAID1 volume equals the capacity of the smallest volume member.

Software RAID5 (deprecated)

A RAID 5 array deploys always THREE or more hard drives. One failing hard drive will have no effect on the system functionality. The capacity of a RAID5 volume equals the capacity of N-1 TBYTE, were N=the number of hard drives in the RAID5 volume. RAID5 is deprecated for use with Apresa because 1) the chance to rebuild a RAID5 volume build with the modern high-capacity hard drives is not at an acceptable level and 2) the lower write performance of RAID5 will limit the number of channels that can be serviced on an Apresa.

Hardware RAID1

Is in terms of functionality this one behaves just like the 'Software RAID1', but a dedicated RAID interface controller card manages the virtual drive.

Hardware RAID5

Is in terms of functionality this one behaves just like the 'Software RAID5', but a dedicated RAID interface controller card manages the virtual drive. RAID5 is deprecated for use with Apresa because the chance to rebuild a RAID5 volume build with the modern high capacity hard drives is not at an acceptable level. The use of a high quality RAID controller with write cache & battery backup, will provide enough write performance for an Apresa with a high number of channels, but when considering the chance of rebuild success RAID5 is not an option to consider.

Hardware RAID10

This combo of RAID0 and RAID1 is an excellent choice for Apresa with a high number of channels.

Use the advised controller with cache/BBU for best write speed and reliable rebuild.

9.2. General information

The hard drive/RAID condition is continuously monitored by APRESA and the status shown to the user under **Tools** -> **System** -> **System Information**.

Storage in ALARM

Hard disks:	DISK sda. 1862 GB	
Software RAID:	Not used	
Hardware RAID:	RAID5	
Card driver:	Driver not installed	
Recording cards:	None	
MAC addresses:	eth0: 0c:c4:7a:93:1f:2a eth1: 0c:c4:7a:93:1f:2b	

System health			
Measured quantity	Value	Status	
Hardware			
Power Supply		OK	=
Hardware sensors			
ACPI Thermal Zone Virtual Device temp1	+27.8°C	OK	=
ACPI Thermal Zone Virtual Device temp2	+29.8°C	OK	=
CPU Temperature Physical id 0	+28.0°C	OK	=
CPU Temperature Core 0	+24.0°C	OK	=
CPU Temperature Core 1	+28.0°C	OK	=
Hardware interfaces			
Recording cards	0	OK	=
Storage			
Temperature of hard disk sda	0 °C	OK	=
Hard disk SATA0		ALARM	=
RAID partition 0	Online	info	
RAID partition 1	Online	info	
HD partition usage /	23%	OK	=

Storage Ok

Hard disks:	DISK sda. 1862 GB	
Software RAID:	Not used	
Hardware RAID:	RAID5	
Card driver:	Driver not installed	
Recording cards:	None	
MAC addresses:	eth0: 0c:c4:7a:93:1f:2a eth1: 0c:c4:7a:93:1f:2b	

System health			
Measured quantity	Value	Status	
Hardware			
Power Supply		OK	=
Hardware sensors			
ACPI Thermal Zone Virtual Device temp1	+27.8°C	OK	=
ACPI Thermal Zone Virtual Device temp2	+29.8°C	OK	=
CPU Temperature Physical id 0	+27.0°C	OK	=
CPU Temperature Core 0	+21.0°C	OK	=
CPU Temperature Core 1	+27.0°C	OK	=
Hardware interfaces			
Recording cards	0	OK	=
Storage			
Temperature of hard disk sda	0 °C	OK	=
Hard disk SATA0		OK	=
RAID partition 0	Online	info	
RAID partition 1	Online	info	
RAID partition 2	Online	info	
HD partition usage /	23%	OK	=

Note: Occurred alarms must be manually cleared by hitting the 'Reset resettable alarms' button below the System Information panel.

During configuration, the user can select how the APRESA will report alarm conditions. When configured properly, an alarm condition can be reported by:

- E-mail
- And/or SNMP
- And/or the alarm card option (Vidicode ART. 010.04663).

9.3. *How to replace a failing hard drive in a HARDWARE-RAID volume*

On the server, the failing hard drive is easily identified by a RED LED permanently lit on. Because the hard drives support hot insertion, just replace the defective one for a new one. The newly inserted drive will automatically be detected by the hardware RAID-controller and be rebuild into the RAID volume. During process that take 1 or more hours, of rebuilding the RED LED is flashing, to be turned off when fully rebuild. When you use RAID5, build with high capacity hard drives, you may wait forever.

9.4. *Replacing a failed hard disk in a RAID array*

Apresa - Replacing a failed hard disk in a RAID array

During this procedure, it is needed to log on the Apresa system shell. The system shell can be reached remotely, with SSH (PuTTY), if "Enable remote shell" is enabled in the system settings, or it can be done locally by connecting a monitor and keyboard to the Apresa machine, and rebooting. Use the following log in account:

User name: vidi

Password: -- For default password, see official manual --

To find out which drive has failed, open the web interface, and log on as administrator. Open the Tools menu, choose System, click the System Information button, and look for the hard disk marked with an error. Alternatively, it can also be found out from the command line, as follows:

cat /proc/mdstat

For RAID-1:

If you see [UU] then both drives are OK.

If you see [_U] then the first drive (SATA0) has failed.

If you see [U_] then the second drive (SATA1) has failed.

For RAID-5:

If you see [UUU] then all three drives are OK.

If you see [_UU] then the first drive (SATA0) has failed.

If you see [U_U] then the second drive (SATA1) has failed.

If you see [UU_] then the third drive (SATA2) has failed.

If you are replacing the first hard disk, then make sure the second hard disk is bootable, by issuing the following command:

sudo grub-install /dev/sdb

When prompted for a password, use the same password as previously.

Shutdown the system, as follows, in the web interface: Tools

menu=>System=>Shutdown system. Or alternatively, from the command line:

sudo poweroff

Then, replace the failed hard disk, with a new empty one with the same size, reboot, and log on in the system shell (command prompt).

We need to prepare and then add the replaced drive to the RAID array. The commands that we need to issue, depends on which drive we have replaced.

Disks in Linux are numbered from sda, sdb, sdc, etc. It is needed to copy the partition structure from the old disk to the new disk. Assuming the old disk is sdb, and the new disk is called sda, the next command should display *no partitions*.

sudo sfdisk -d /dev/sda

Important: If it displays partitions, then stop, because continuing will damage the data on disk. The new disk should not contain data.

The next command (the existing hard disk) should display a list of partitions.

sudo sfdisk -d /dev/sdb

If this is so, then proceed to the following command. Be very careful to write this command correctly.

sudo sfdisk -d /dev/sdb | sudo sfdisk --force /dev/sda

This copies the partition layout from sdb to sda. If your new disk has another drive letter, then adjust the commands as necessary.

Type **cat /proc/mdstat | grep md** to view the mapping between RAID (md) and hard disk (sd) partitions. For example:

```
md3 : active raid1 sdb4[0]
```

This example output indicates that md3 contains sdb4. For RAID1, each md partition should contain a partition on sda and the same numbered partition on sdb (and for RAID5 it should also contain a partition on sdc). In the example, this would mean we should add sda4 to md3, but you should check if your situation is the same. To add a hard disk partition to the RAID array, proceed as follows:

sudo mdadm -a /dev/mdX /dev/sdaY

replacing X and Y with corresponding numbers, learned from the earlier output.

Repeat this for all mentioned md partitions.

After these commands, synchronization will proceed automatically. It takes more than three hours for 1 TB hard disks. You can see the progress in the web interface (Tools=>System=>System Information). Or alternatively, the progress can be queried from the command line, as follows:

cat /proc/mdstat

After completion, make the new drive bootable, as follows: (from the command line)

sudo grub-install /dev/sda

10. Advised hardware RAID controller card

There are several brands of RAID controller cards available on the market in a price range from € 40 to well over €1000. The selection criteria are:

- Reliable, server-grade manufacturer;
- Support of the required RAID configuration;
- Speed of write operation will become increasingly important with the number of channels to serve by Apresa.

Vidicode advises to use as Hardware RAID controller card:

-Super Micro/LSI AOC S3108L-H8iR 8-port HW Raid card 12Gb/s
+ option : BTR-TFM8G-LSICVM02 (cache & backup)

The cards can be used for both hardware-RAID1 and hardware-RAID10

SOFTWARE RAID5 & HARDWARE RAID5 are DEPRECATED

Note that early in the setup of the Apresa system, even before base software installation the user must assign hard drives to a virtual drive to build the RAID volume, the 'Redundant Array of Independent Drives'.

This is how to setup the RAID-volume for the LSI RAID controller advised earlier:

1. Install/screw the RAID controller card in a free PCI-e x8 slot;
2. Turn on the APRESA server and, during the boot, press CTRL+R when asked for;
3. Press F2 to enter operations;
4. Go to 'Make un-configured good' mark drives 'X' to turn drives un-configured;
5. Select 'LSI MegaRAID' and press F2 to enter 'operations';
6. Select RAID1 or RAID10, create virtual drive;
7. When asked for initialization, just skip that;
8. Done.

NOTE: StorCLI needs to be installed in APRESA (see 2.9.12)

11. INTERFACE CARD SPECIFICATIONS

To establish a technical correct tap on the various types of communication links the installer must have some basic information about the interface cards deployed inside the APRESA recorder.

Common characteristics for all interface cards:

- All cards are basically PC- PCIe expansion cards;
- All PCI are V2.2, 133 MB/sec, PNP (plug and play) Compatible with 3V3 and 5V PCI bus;
- All PCIe X1 that will fit also into X4/X8/X16x32 PCIe-slots;
- NO jumpers;
- All line interfaces are based on 'PASSIVE TAPPING';
- On-board DSP(s) for effective VOICE compression;
- No telecom line termination possible, also not required.

11.1. ATP-24A/PCI+/2.0 / ATP-24A/PCIe+/2.0 / ATP-24A/PCIe+/3.0

This type of interface card is typically used for the recording of:

- Analog subscriber lines (POTS)
- Plain AUDIO signals.

The base-board supports 8 ANALOG channels but is expandable to 16 or 24 channels in total by the application of 1 or 2 expansion boards.

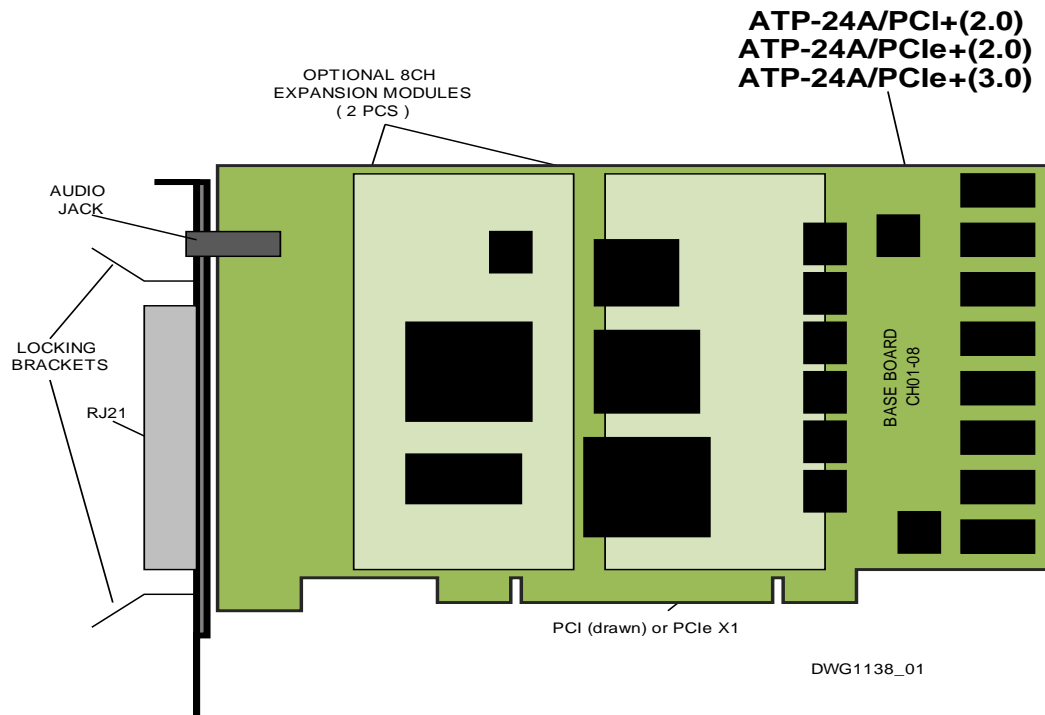

Key specifications overview:

# channels	8, 16 or 24
Size	160x111 mm (excluding the bracket)
Impedance	10KOHM AC / > 1MOHM DC /
Sensitivity	8mV 750mV, by 16 steps.
Input connector	RJ21 (50 pin)
TAP type	High-Impedance passive monitoring by parallel connection
Isolation	500 VDC
Power dissipation	<8 W (3V3@900mA / 5V@200mA / 12V@100mA)
Sample rate	8KHz
Frequency response	300-3400 Hz (±3dB)
Signal to Noise ratio	>34 dB
Dynamic input range	-40 +10dB

11.2. DST-24B/PCI+/2.0 / DST-24B/PCle+/2.0

This type of interface card is typically used for the recording of:

- TDM
- ISDN2

The base-board supports 8 DIGITAL channels but is expandable to 16 or 24 channels in total by the application of 1 or 2 expansion boards.

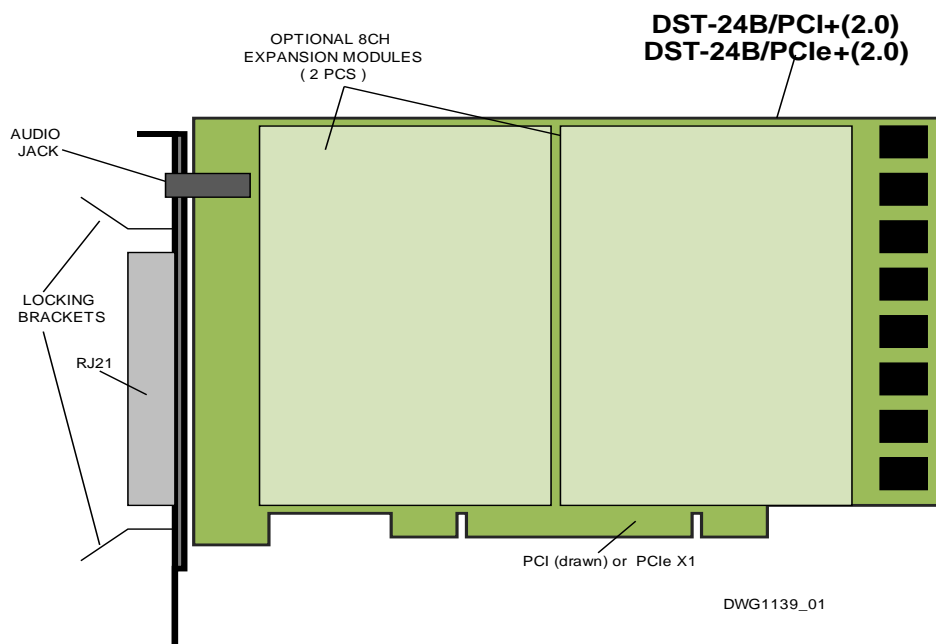

Key specifications overview:

# channels	8, 16 or 24
Size	160x111 mm (excl bracket)
Impedance	1000 OHM AC / > 20MOHM DC /
Input connector	RJ21 (50 pin)
TAP type	High-Impedance passive monitoring by parallel connection
Isolation	500VDC
Power dissipation	< 9 W (3V3@1300mA / 5V@50mA / 12V@300mA)
Sample rate	8 KHz
Frequency response	300-3400 Hz (± 3 dB)
Signal to Noise ratio	>34 dB

11.3. DTP-X0C/PCI+ / DTP-X0C/PCle+

This type of interface card is typically used for the recording of:

- ISDN-E1 (European type ISDN 'primary' rate, 30 recording channels)
- ISDN-T1 (USA type ISDN 'primary' rate, 24 recording channels)

There are 3 version supporting 1, 2 or 4 trunk lines.

PCI : 1-TRUNK:DTP-30C/PCI+ 2-TRUNK:DTP-60C/PCI+ 4-TRUNK:DTP-120C/PCI+
 PCle : 1-TRUNK:DTP-30C/PCle+ 2-TRUNK:DTP-60C/PCle+ 4-TRUNK:DTP-120C/PCle+

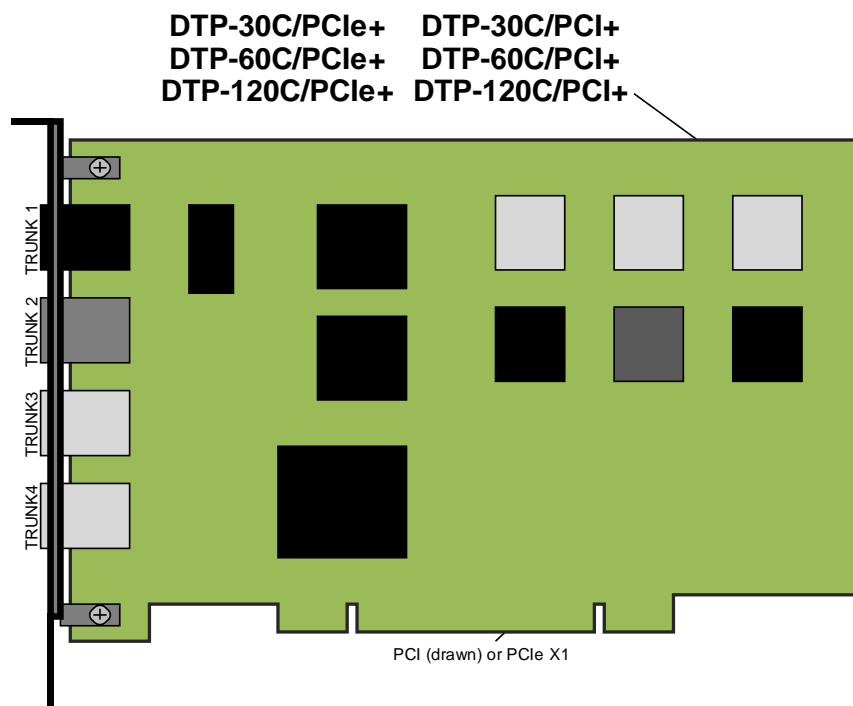

Key specifications overview:

#Trunks	1, 2 or 4
# channels T1 (USA)	24, 48, 96
# channels E1	30, 60, 120
Size	160x112 mm (excluding the bracket)
Impedance T1	75 OHM unbalanced / 120 OHM balanced
Impedance E1	100-110 OHM balanced
Input interface imp.	1KOHM
Input connector	RJ45 (8 pin modular)
TAP type	High-Impedance passive monitoring by parallel connection
Isolation	500VDC
Power dissipation	< 5 W (3V3@1500mA)
Sample rate	8KHz
Frequency response	300-3400 Hz (±3dB)
Signal to Noise ratio	>34 dB

Signaling systems SS1 / SS7 / DSSS1

11.4. GNU GENERAL PUBLIC LICENSE.

Some portions of the device software are covered by the GNU General Public License. The source code of these portions will be provided upon request for a charge of no more than the cost of physically performing the source distribution under the terms of Sections 1 and 2 of the GPL License *) on a medium customarily used for software interchange. The GPL License can be found on the Application CD in your CR APRESA package under the directory **Licenses**.

If you want to receive the source code, contact VIDICODE:



VIDICODE
Blauw-roodlaan 140
2718 SK Zoetermeer
The Netherlands

Tel: +31 793617181
Fax: +31 793618092

E-mail info@vidicode.com

12. TERMINOLOGY EXPLAINED

COMMISSIONING=

A procedure using predefined performance criteria to check a system for acceptance by the end user.

HIGH IMPEDANCE TAPPING=

A method used to extract data from a communication line with minimal electric disturbance.

INBOUND CALL=

An external phone makes a call to a local phone

INTERNAL CALL=

A call between 2 local phones, also called a local call

ITSP=

Internet telephony service provider

JBOD=

An acronym for 'Just a bunch of drives'. A group of hard drives under a RAID controller are not set up as any type of RAID volume. These drives are available to the operating system as an individual disk. JBOD does not provide data redundancy. JBOD is not supported by APRESA

LOCAL CALL=

A call between 2 local phones, also called a internal call

OUTBOUND CALL=

A local phone makes a call to an external phone

RAID=

Is an acronym for 'Redundant Array of Independent Drives'. Refers to an array of multiple independent hard drive drives that provides high performance and fault tolerance. The APRESA supports Single Disk, RAID1 and RAID5

RAID0=

RAID 0, also referred to as 'striping', writes stripes of data across multiple disk drives instead of just one disk drive. RAID 0 does not provide data redundancy, but it does offer the best high-speed data throughput. RAID 0 breaks up data into smaller blocks and then writes a block to each drive in the array. Disk striping enhances performance because multiple drives are accessed simultaneously. The reliability of RAID 0 is less because the entire array will fail if any one disk drive fails, due to a lack of redundancy.

RAID1=

RAID 1 is also known as 'disk mirroring'; data written on one disk drive is simultaneously written to another disk drive. Read performance will be enhanced if the array controller can, parallel, access both members of a mirrored pair. During writes, there will be a minor performance penalty when compared to writing to a single disk. If one drive fails, all data (and software applications) are preserved on the other drive. RAID 1 offers extremely high data reliability, at the cost of doubling the required data storage capacity.

RAID 5=

RAID 5 is sometimes called striping with parity at byte level. In RAID 5, the parity information is distributed over all the drives in the volume rather than being concentrated on a dedicated parity disk. If one drive in the system fails, the parity information can be used to reconstruct the data from that drive. All drives in the volume can be used for seek operations at the same time, greatly increasing the read performance of the RAID system. The use of RAID5 is not advised with a write intensive product like APRESA. RAID5 is generally problematic on rebuild when using high capacity hard drives in terms of success rate and time involved due to the endless disk reads and parity calculations involved during rebuild.

JUST DON'T USE IT FOR APRESA

SNMP=

Simple Network Management Protocol. Is an IP-based protocol to obtain the status of SNMP-client network devices. The SNMP management platform is called the SNMP manager, and the managed devices have the SNMP agent loaded.

SOFTWARE CONFIGURATION=

The setup of installed software to meet the requirements of the user(s)

SOFTWARE INSTALLATION=

This is the process of installing of a software package on a computer. This is normally followed by the software configuration.

STATION SIDE RECORDING=

Recording the calls between local phones

STUB LENGTH=

The length of an un-terminated segment of a transmission line. Applies to the length of the cable between the tap and the APRESA recorder. The maximum length allowed varies with the brand of the PBX and the telecom wiring. Exceeding the maximum stub length will degrade the quality and the reliability of the voice link.

TRUNK SIDE RECORDING=

Recording the calls to the external phone network, the outbound and the inbound calls.

U=

Unit to specify the height of 19-Inch rack devices 1U = 44.45mm

VOIP=

An acronym for 'VOICE OVER INTERNET PROTOCOL'

POTS=

An acronym for 'Plain old telephone system'. Commonly called analog telephony.

ISDN2=

An acronym for 'Integrated Services Digital Network' 2 channels. Also, called basic rate ISDN

ISDN-E1=

An acronym for 'Integrated Services Digital Network' 30 channels. Also, called primary rate ISDN. Used everywhere except in the USA and Japan.

ISDN-T1=

An acronym for 'Integrated Services Digital Network' 24 channels. Also called primary rate ISDN. Used in the USA.

ISDN-J1=

An acronym for 'Integrated Services Digital Network' 30 channels. Also called primary rate ISDN. Used in Japan only.

MIRRORING SWITCH=

Ethernet switch capable of copying the network traffic on one or more (source) ports to a destination port. Managed switches offer port mirroring.

REDUNDANT POWER SUPPLY=

Power supply used in high availability installation. Build with two power packs and allows one power pack to fail without interruption of the computing.

13. COPYRIGHT AND TRADEMARKS

The information of the products in this manual is subject to change without prior notice and does not represent a commitment on the part of the vendor, who assumes no liability or responsibility for any errors that may appear in this manual. All brands and trademarks are the properties of their respective owners. This manual contains materials protected under International Copyright Conventions. All rights reserved. No part of this manual may be reproduced in any form or by any means, electronic or mechanical, including photocopying, without the written permission of the manufacturer and the author. All inquiries should be addressed Vidicode.

14. FCC STATEMENT

This equipment has been tested and found to comply with the limits for a Class B digital device, pursuant to part 15 of the FCC Rules. These limits are designed to provide reasonable protection against interference in a residential installation. This equipment generates, uses, and can radiate radio frequency energy and, if not installed and used in accordance with the instructions, may cause harmful interference to radio communications. However, there is no guarantee that interference will not occur in a particular installation.

15. RoHS 2 STATEMENT



Vidicode hereby declares and certifies that all APRESA hardware is RoHS 2 5/6 compliant according to the definitions and restrictions given by the Directive 2011/65/ EU of The European Parliament and of the Council of June 8, 2011 on the restriction of the use of certain hazardous substances in electrical and electronic equipment (EEE). Restricted substances referred to in Article 4(1) and maximum concentration values tolerated by weight in homogenous materials:

1. Lead (Pb) 0.1%
2. Mercury (Hg) 0.1%
3. Cadmium (Cd) 0.01%
4. Hexavalent Chromium (CrVI) 0.1%

5. Polybrominated Biphenyls (PBB) 0.1%
6. Polybrominated Diphenyl Ethers (PBDE) 0.1%